

NİSAN 2026

**FİYAT
LİSTESİ**



Sıralama	Ürünler	Markalar	SayfaNo	İskontolar
1	Çelik Tesisat Boruları	Çayırova	3	
2	Tesisat Bağlantı Parçaları	TrakyaDöküm	5	
		Flanşlar	7	
		Patent Dirsek	9	
		Maşonlar	10	
		Patent Ek Parçalar	11	
		Kelepçe	17	
3	Flanşlı Vana ve Elemanları	Faf	18	
		Unival	48	
		Emniyet Ventilleri	63	
4	Prinç Vanalar Ve Ek Parçaları	Konsan	65	
		Case	70	
		Aravalf	74	
		Pirinç Ek Parçalar	77	
5	Yangın Tesisatı	Unival	81	
		Armaş	87	
		Yangın Vanaları	97	
6	Ölçüm Cihazları-Basınç Kontrol	Termometre -Manometre	100	
7	Isıtma Tesisatı	Buderus	108	
		Wates	109	
		Kodsan	110	
		Separatörler	115	
		Fraenkische	119	
		DemirDöküm	121	
8	Pompa&Hidroforlar	KSB	124	
		Hidroforlar	126	
		Standart	127	
9	Klima Sistemleri	Gree	147	

ÇELİK - TESİSAT

FIYAT LİSTESİ



1986'dan beri

Serdaroglu[®]

TESİSAT TEKNİK MALZEME SAN. TİC. A.Ş.

19.07.2023

Su ve Yangın Tesisat Boruları / TS EN 10255 Orta Seri										
Ebat & Paket Detay						Fiyat (TL / m)				
Çap	Anma Çapı (DN)	Dış Çap (mm)	Et Kalınlığı (mm)	Bağ İçi Adet	Bağ Toplam (m)	Galvanizli Dişli Manşonlu	Galvanizli Düz Uçlu	Siyah Dişli Manşonlu	Siyah Düz Uçlu	Kırmızı Boyalı
1/2"	15	21,3	2,6	217	1302	80,43	75,13	54,74	49,44	52,32
3/4"	20	26,9	2,6	169	1014	96,09	90,16	69,45	63,60	67,17
1"	25	33,7	3,2	91	546	141,05	131,27	105,86	96,04	101,42
1 1/4"	32	42,4	3,2	70	420	181,97	169,76	137,65	123,12	129,90
1 1/2"	40	48,3	3,2	61	366	208,34	193,58	158,22	140,07	147,96
2"	50	60,3	3,6	51	306	291,12	271,42	227,09	198,38	209,25
2 1/2"	65	76,1	3,6	37	222	372,75	347,21	288,25	253,32	267,22
3"	80	88,9	4,0	24	144	478,12	444,51	396,74	329,97	347,96
4"	100	114,3	4,5	19	114	701,75	642,23	558,20	476,53	502,73
5"	125	139,7	5,0	10	60	953,57	848,69	783,28	651,32	687,68
6"	150	165,1	5,0	10	60	1142,96	1053,63	939,83	778,39	821,07

* Su boruları; kırmızı astar boyalı, kumlanmış veya yivli olarak imal edilebilir. Orta seri ürünlerimiz PN 25 sınıfı olup, minimum 80 barda test edilmektedir.

Doğalgaz Tesisat Boruları					
TS EN ISO 3183					
Dış Çap (mm)	Et Kalınlığı (mm)	Bağ İçi Adet	Bağ Toplam	Malzeme Kalitesi	Fiyat (TL / m)
21,3	2,8	217	1302	Grade A	71,11
26,7	2,9	169	1014	Grade A	98,39
33,4	3,4	91	546	Grade A	143,71
42,2	3,6	70	420	Grade A	185,07
48,3	3,7	61	366	Grade A	216,72
60,3	3,9	44	264	Gr B / X42	291,01
73,0	5,2	29	174	Gr B / X42	468,02
88,9	5,5	24	144	Gr B / X42	605,46
114,3	6,0	19	114	Gr B / X42	883,90
141,3	6,6	10	60	Gr B / X42	1.186,04
168,3	7,1	10	60	Gr B / X42	1.545,68
219,1	8,2	7	42	Gr B / X42	2.287,44
273,1	9,3	7	42	Gr B / X42	3.333,71
323,9	9,5	7	42	Gr B / X42	4.065,38

PE Kaplı Doğalgaz Tesisat Boruları					
DIN 30670 / TS 5139					
Dış Çap (mm)	Et Kalınlığı (mm)	Bağ İçi Adet	Bağ Toplam	Malzeme Kalitesi	Fiyat (TL / m)
21,3	2,8	-	-	-	-
26,7	2,9	24	144	Grade A	209,58
33,4	3,4	24	144	Grade A	250,39
42,2	3,6	24	144	Grade A	314,73
48,3	3,7	19	114	Grade A	370,48
60,3	3,9	19	114	Gr B / X42	473,03
73,0	5,2	19	114	Gr B / X42	720,55
88,9	5,5	10	60	Gr B / X42	893,30
114,3	6,0	10	60	Gr B / X42	1.290,00
141,3	6,6	10	60	Gr B / X42	1.774,07
168,3	7,1	10	60	Gr B / X42	2.251,35
219,1	8,2	1	-	Gr B / X42	3.363,33
273,1	9,3	1	-	Gr B / X42	4.928,37
323,9	9,5	1	-	Gr B / X42	6.031,94

* Doğalgaz tesisat boruları API 5L normuna göre kaynak ağırlı olarak imal edilmektedir. Doğalgaz borularımızın korozyon dayanımı yüksek olup, tamamı **normalize** edilmiştir.

* PE kaplı doğalgaz boruları DIN 30670 standardına göre orta/yüksek yoğunlukta **3 kat** olarak Sarı Polietilen kaplanmaktadır.

19.07.2023

Ebatlar		Basınçlı Borular (Siyah Düz Uçlu)														
		TS EN 10217 – 1 Malzeme Kalitesi P235 TR1														
		Et Kalınlığı (mm)														
ÇAP	DIŞ ÇAP (mm)	2,0 mm	2,5 mm	3,0 mm	3,2 mm	3,6 mm	4,0 mm	4,5 mm	5,0 mm	5,6 mm	6,0 mm	6,3 mm	7,1 mm	8,0 mm	9,0 mm	10,0 mm
1/2"	21,3	41,20	50,84	54,24	-	-	-	-	-	-	-	-	-	-	-	-
3/4"	26,9	50,79	64,73	69,75	-	-	-	-	-	-	-	-	-	-	-	-
1"	33,7	63,26	79,62	88,76	-	110,04	123,48	-	-	-	-	-	-	-	-	-
1 1/4"	42,4	81,62	98,66	114,41	-	141,60	148,26	200,86	217,50	-	-	-	-	-	-	-
1 1/2"	48,3	93,50	115,74	131,86	-	165,98	183,42	222,68	261,80	-	-	-	-	-	-	-
	51,0	-	129,87	159,84	-	170,74	203,25	-	-	-	-	-	-	-	-	-
2"	60,3	-	140,60	168,32	187,49	207,39	217,19	261,52	322,05	353,71	-	-	-	-	-	-
2 1/2"	76,1	-	175,36	210,08	239,69	269,29	282,41	319,93	413,23	461,53	507,48	-	-	-	-	-
3"	88,9	-	205,07	244,51	294,54	300,72	333,55	376,95	464,77	516,34	544,84	-	-	-	-	-
4"	114,3	-	271,28	317,50	367,67	390,26	433,76	480,50	558,43	613,37	694,99	725,76	828,13	-	-	-
5"	139,7	-	-	396,82	451,51	487,48	551,70	614,41	657,60	773,70	883,12	924,45	1.042,16	1.163,07	-	-
6"	165,1	-	-	494,18	-	570,81	654,84	740,16	799,20	923,11	1.048,04	1.098,98	1.182,82	1.398,83	-	-
	168,3	-	-	526,89	-	-	664,93	753,92	824,25	937,78	1.067,95	1.116,63	1.199,72	1.411,12	-	-
	193,7	-	-	-	-	-	825,83	935,46	1.022,87	1.162,40	1.316,77	1.407,06	1.490,76	1.677,34	-	-
8"	219,1	-	-	660,00	-	765,00	942,94	1.035,63	1.152,81	1.292,17	1.418,83	1.443,40	1.619,62	1.816,17	2.212,80	2.501,28
10"	273,0	-	-	-	-	-	1.204,74	1.329,03	1.481,37	1.650,31	1.809,82	1.856,60	2.085,38	2.343,36	2.896,23	3.196,91
12"	323,9	-	-	-	-	-	-	1.542,24	1.708,81	1.914,27	2.132,93	2.176,25	2.446,83	2.761,64	3.371,53	3.754,57

Ebatlar		Basınçlı Borular (Kırmızı Boyalı Düz Uçlu)														
		TS EN 10217 – 1 - Malzeme Kalitesi: P235 TR1														
		Et Kalınlığı (mm)														
ÇAP	DIŞ ÇAP (mm)	2,0 mm	2,5 mm	3,0 mm	3,2 mm	3,6 mm	4,0 mm	4,5 mm	5,0 mm	5,6 mm	6,0 mm	6,3 mm	7,1 mm	8,0 mm	9,0 mm	10,0 mm
1/2"	21,3	43,62	53,98	57,54	-	-	-	-	-	-	-	-	-	-	-	-
3/4"	26,9	53,75	68,60	73,88	-	-	-	-	-	-	-	-	-	-	-	-
1"	33,7	67,76	84,74	94,57	-	116,84	130,80	-	-	-	-	-	-	-	-	-
1 1/4"	42,4	86,52	104,97	122,49	-	150,45	157,08	211,17	229,66	-	-	-	-	-	-	-
1 1/2"	48,3	99,13	123,41	139,78	-	175,49	194,29	235,86	276,26	-	-	-	-	-	-	-
	51,0	-	137,71	168,98	-	181,78	215,76	-	-	-	-	-	-	-	-	-
2"	60,3	-	149,89	179,10	198,29	220,18	230,78	278,28	339,77	373,09	-	-	-	-	-	-
2 1/2"	76,1	-	186,86	224,50	256,46	286,18	302,16	340,18	436,96	488,77	536,29	-	-	-	-	-
3"	88,9	-	217,76	259,99	311,96	319,30	355,83	401,69	491,44	547,69	575,26	-	-	-	-	-
4"	114,3	-	288,18	339,36	388,49	415,80	461,77	509,79	594,43	650,74	735,88	772,01	873,79	-	-	-
5"	139,7	-	-	420,60	479,87	518,84	587,07	651,65	699,46	820,76	936,83	978,93	1.102,52	1.226,27	-	-
6"	165,1	-	-	525,50	-	611,54	693,80	785,06	842,65	984,61	1.106,63	1.162,44	1.253,04	1.494,18	-	-
	168,3	-	-	557,78	-	-	707,08	792,17	872,34	995,04	1.130,18	1.182,46	1.278,31	1.524,51	-	-
	193,7	-	-	-	-	-	875,62	998,51	1.084,10	1.225,28	1.369,67	1.479,03	1.577,87	1.769,79	-	-
8"	219,1	-	-	706,20	-	818,55	989,05	1.090,06	1.212,78	1.358,80	1.492,10	1.519,72	1.700,72	1.911,32	2.324,64	2.622,80
10"	273,0	-	-	-	-	-	1.262,72	1.398,73	1.551,13	1.734,70	1.906,03	1.957,09	2.190,54	2.461,53	3.038,12	3.354,64
12"	323,9	-	-	-	-	-	-	1.622,63	1.797,52	2.014,20	2.241,40	2.285,99	2.565,41	2.899,31	3.532,42	3.934,85

Kazan Boruları				
TS EN 10217 - 2				
Dış Çap (mm)	Et Kalınlığı (mm)	Bağ İçi Adet	Malzeme Kalitesi	Fiyat (TL / m)
48,3	3,2	37	P235GH	184,30
51,0	3,2	37	P235GH	193,22
57,0	3,2	37	P235GH	214,93
63,5	3,2	37	P235GH	237,60
76,1	3,2	37	P235GH	279,46
88,9	3,6	37	P235GH	385,09

Beton Pompa Boruları				
TS EN 10217-1				
Dış Çap (mm)	Et Kalınlığı (mm)	Bağ İçi Adet	Malzeme Kalitesi	Fiyat (TL / m)
133,0	4,0	19	S355J2	621,32

* Kazan boruları 7 metre boyunda, siyah boyalı ve iç çapaksız olarak üretilir.



TESİSAT BAĞLANTI

FİYAT LİSTESİ



1986'dan beri

Serdaroğlu[®]

TESİSAT TEKNİK MALZEME SAN. TİC. A.Ş.

01.03.2026

FITTINGS -2

Figür No.	Stand.No.	cİNSİ	ÖLÇÜ	1/2"	3/4"	1"	1 1/4"	1 1/2"	2"	2 1/2"	3"	4"
				15	20	25	32	40	50	65	80	100
90	A1	DİRSEK	Siyah	19,00	29,00	44,00	92,00	148,00	171,00	500,00	680,00	1.160,00
			Galvaniz	24,00	37,00	55,00	115,00	185,00	214,00	626,00	850,00	1.456,00
130	B1	TE	Siyah	29,00	48,00	68,00	128,00	190,00	275,00	620,00	820,00	1.510,00
			Galvaniz	37,00	60,00	86,00	160,00	238,00	346,00	775,00	1.025,00	1.888,00
280	N8	NİPEL	Siyah	21,00	27,00	37,00	66,00	78,00	135,00	250,00	292,00	1.025,00
			Galvaniz	27,00	34,00	47,00	83,00	98,00	171,00	313,00	367,00	1.295,00
92	A4	KUYRUKLU	Siyah	26,00	38,00	61,00	112,00	160,00	214,00	525,00	690,00	1.134,00
			Galvaniz	33,00	48,00	77,00	140,00	200,00	268,00	657,00	863,00	1.418,00
340	U11	KONİK RAKOR	Siyah	104,00	117,00	136,00	236,00	277,00	451,00	970,00	1.295,00	2.590,00
			Galvaniz	130,00	147,00	170,00	295,00	347,00	564,00	1.219,00	1.619,00	3.238,00
341	U12	KUYRUKLU	Siyah	103,00	124,00	154,00	243,00	310,00	504,00	1.060,00	1.680,00	3.020,00
			Galvaniz	129,00	155,00	193,00	304,00	388,00	630,00	1.337,00	2.100,00	3.827,00
270	M2	MANŞON	Siyah	24,00	33,00	41,00	67,00	94,00	141,00	395,00	465,00	1.075,00
			Galvaniz	30,00	42,00	52,00	84,00	119,00	178,00	494,00	588,00	1.359,00
290	T9	TAPA	Siyah	18,00	23,00	25,00	46,00	60,00	103,00	220,00	275,00	496,00
			Galvaniz	23,00	29,00	32,00	58,00	75,00	129,00	275,00	344,00	620,00
291	T8	TAPA KORDONSUZ	Siyah	20,00	25,00	28,00	50,00	66,00	113,00	242,00	302,00	545,00
			Galvaniz	25,00	31,00	35,00	63,00	83,00	141,00	302,00	377,00	680,00
300	T1	KAPAK - TAPA	Siyah	27,00	33,00	39,00	57,00	71,00	131,00	241,00	263,00	565,00
			Galvaniz	34,00	42,00	49,00	72,00	90,00	164,00	302,00	329,00	707,00
180	C1	KRUYA	Siyah	99,00	150,00	182,00	242,00	319,00	473,00	1.085,00	1.250,00	
			Galvaniz	124,00	188,00	228,00	306,00	402,00	599,00	1.357,00	1.575,00	
330	U1	DÜZ RAKOR	Siyah	88,00	101,00	114,00	204,00	248,00	407,00	930,00	1.300,00	
			Galvaniz	110,00	127,00	143,00	255,00	310,00	509,00	1.165,00	1.625,00	
120	A1/45°	45° DİRSEK	Siyah	68,00	84,00	125,00	218,00	270,00	351,00	725,00	755,00	
			Galvaniz	86,00	105,00	157,00	277,00	338,00	443,00	917,00	944,00	
2A	D1	KISA DEVEBOYNU	Siyah	52,00	69,00	110,00	162,00	219,00	347,00	644,00	1.109,00	
			Galvaniz	65,00	87,00	138,00	203,00	274,00	434,00	805,00	1.387,00	
310	P4	İNCE SOMUN	Siyah	21,00	22,00	34,00	48,00	53,00	100,00	225,00		
			Galvaniz	27,00	28,00	43,00	60,00	67,00	125,00	282,00		
95	UA1	90° KÖŞE DÜZ	Siyah	140,00	154,00	190,00	331,00	460,00	686,00			
			Galvaniz	175,00	193,00	238,00	414,00	575,00	858,00			
96	UA11	90° KÖŞE KONİK	Siyah	139,00	161,00	231,00	388,00	455,00	770,00			
			Galvaniz	174,00	202,00	289,00	485,00	569,00	963,00			
97	UA2	90° KUYRUKLU DÜZ	Siyah	143,00	172,00	217,00	370,00	499,00	727,00			
			Galvaniz	179,00	215,00	272,00	467,00	624,00	909,00			
98	UA12	90° KUYRUKLU KONİK	Siyah	139,00	178,00	243,00	403,00	504,00	818,00			
			Galvaniz	174,00	223,00	304,00	504,00	630,00	1.023,00			
1	G4	DEVEBOYNU	Siyah	61,00	101,00	138,00	239,00	308,00	509,00			
			Galvaniz	77,00	127,00	173,00	299,00	385,00	637,00			
1A	D4	KISA DEVEBOYNU	Siyah	55,00	85,00	114,00	165,00	242,00	424,00			
			Galvaniz	69,00	107,00	143,00	207,00	303,00	530,00			
2	G1	DEVEBOYNU	Siyah	68,00	106,00	140,00	250,00	299,00	413,00			
			Galvaniz	85,00	133,00	175,00	313,00	374,00	517,00			
40	G4/45°	45° DEVEBOYNU	Siyah	67,00	92,00	128,00	220,00	264,00	410,00			
			Galvaniz	84,00	115,00	160,00	275,00	330,00	513,00			
41	G1/45°	45° DEVEBOYNU	Siyah	83,00	99,00	129,00	227,00	296,00	418,00	330SBR		
			Galvaniz	104,00	124,00	162,00	284,00	370,00	523,00	1" D.GAZ SAYAÇ BAĞLAMA RAKORU (SOMUNLU) L62	100,00	
271	M2 R-L	MANŞON	Siyah	38,00	49,00	63,00	120,00	133,00	232,00			
			Galvaniz	48,00	62,00	79,00	150,00	167,00	292,00			
331	U2	KUYRUKLU	Siyah	100,00	109,00	133,00	232,00	286,00	442,00	330 SBTR		
			Galvaniz	126,00	137,00	167,00	292,00	362,00	561,00	1" D.GAZ SAYAÇ BAĞLAMA TEST RAKORU (Somunlu) L80	145,00	
121	A4/45°	45° KUYRUKLU	Siyah	64,00	83,00	124,00	228,00	248,00	317,00			
			Galvaniz	80,00	104,00	155,00	285,00	310,00	397,00			
85		BORU ATLAMA	Siyah	85,00	130,00	264,00				270 DTM		
			Galvaniz	107,00	163,00	330,00				1" DOĞALGAZ TEST MANŞONU	67,00	
131	E1	KULPLU TE	Siyah	112,00	138,00	211,00						
			Galvaniz	140,00	173,00	264,00						
529A	M4	MANŞON	Siyah	46,00	64,00	104,00				270 DTM		
			Galvaniz	58,00	80,00	130,00				1/2" DOĞALGAZ TEST MANŞONU	53,00	
90DT		DOĞALGAZ TEST DİRSEĞİ	Siyah		66,00	79,00	125,00	176,00	272,00			

01.03.2026

FITTINGS -2

Td	Stand. No.	Cinsi	Ölçü	3/4"-1/2"	1"-1/2"	1"-3/4"	1 1/4"-1/2"	1 1/4"-3/4"	1 1/4"-1"	1 1/2"-1/2"	1 1/2"-3/4"			
241	N4	REDÜKSİYON	Ölçü	21,00	32,00	27,00	56,00	49,00	37,00	68,00	79,00			
			Galvaniz	27,00	40,00	34,00	71,00	62,00	47,00	87,00	99,00			
			Ölçü	1 1/2"-1"	1 1/2"-1 1/4"	2"-1/2"	2"-3/4"	2"-1"	2"-1 1/4"	2"-1 1/2"	2 1/2"-1"			
			Siyah	53,00	53,00	139,00	137,00	113,00	108,00	96,00	230,00			
			Galvaniz	67,00	67,00	175,00	173,00	143,00	136,00	122,00	288,00			
			Ölçü	2 1/2"-1 1/4"	2 1/2"-1 1/2"	2 1/2"-2"	3"-1"	3"-1 1/4"	3"-1 1/2"	3"-2"	3"-2 1/2"			
			Siyah	261,00	250,00	188,00	350,00	350,00	330,00	247,00	278,00			
			Galvaniz	327,00	313,00	238,00	442,00	442,00	413,00	309,00	348,00			
			Ölçü	4"-2"	4"-2 1/2"	4"-3"								
			Siyah	685,00	520,00	500,00								
			Galvaniz	863,00	658,00	631,00								
			240	M2	MANŞON REDÜKSİYON	Ölçü	3/4"-1/2"	1"-1/2"	1"-3/4"	1 1/4"-3/4"	1 1/4"-1"	1 1/2"-1/2"	1 1/2"-3/4"	1 1/2"-1"
Siyah	40,00	52,00				48,00	89,00	86,00	151,00	133,00	104,00			
Galvaniz	51,00	66,00				60,00	112,00	108,00	189,00	169,00	130,00			
Ölçü	1 1/2"-1 1/4"	2"-1/2"				2"-3/4"	2"-1"	2"-1 1/4"	2"-1 1/2"	3"-1 1/2"	3"-2"			
Siyah	142,00	264,00				275,00	254,00	225,00	214,00	621,00	906,00			
Galvaniz	142,00	264,00				275,00	250,00	225,00	213,00	615,00	900,00			
Ölçü	3"-2 1/2"	4"-2"				4"-3"								
Siyah	820,00	1.230,00				1.340,00								
Galvaniz	1.031,00	1.567,00				1.675,00								
245	N8	NİPEL REDÜKSİYON				Ölçü	3/4"-1/2"	1"-1/2"	1"-3/4"	1 1/4"-1/2"	1 1/4"-3/4"	1 1/4"-1"	1 1/2"-1/2"	1 1/2"-3/4"
						Siyah	45,00	86,00	50,00	131,00	114,00	80,00	127,00	113,00
						Galvaniz	57,00	108,00	63,00	164,00	143,00	100,00	159,00	142,00
			Ölçü	1 1/2"-1"	1 1/2"-1 1/4"	2"-1"	2"-1 1/4"	2"-1 1/2"	2 1/2"-2"	3"-2"	3"-2 1/2"			
			Siyah	178,00	97,00	161,00	202,00	185,00	450,00	545,00	715,00			
			Galvaniz	227,00	124,00	202,00	253,00	232,00	563,00	685,00	896,00			
			Ölçü	4"-3"										
			Siyah	1.320,00										
			Galvaniz	1.650,00										
			130R	B1	İNEGAL TE	Ölçü	1/2"-3/4"-1/2"	3/4"-1/2"-1/2"	3/4"-1/2"-3/4"	3/4"-3/4"-1/2"	3/4"-1"-1/2"	3/4"-1"-3/4"	1"-1/2"-1/2"	1"-1/2"-3/4"
						Siyah	62,00	62,00	62,00	62,00	103,00	103,00	103,00	103,00
						Galvaniz	78,00	78,00	78,00	78,00	130,00	130,00	130,00	130,00
Ölçü	1"-1/2"-1"	1"-3/4"-1/2"				1"-3/4"-3/4"	1"-3/4"-1"	1"-1 1/4"-3/4"	1"-1 1/4"-1"	1 1/4"-1/2"-1"	1 1/4"-1/2"-1 1/4"			
Siyah	103,00	103,00				103,00	103,00	168,00	168,00	151,00	151,00			
Galvaniz	130,00	130,00				130,00	130,00	211,00	211,00	189,00	189,00			
Ölçü	1 1/4"-3/4"-1"	1 1/4"-3/4"-1 1/4"				1 1/4"-1"-1/2"	1 1/4"-1"-3/4"	1 1/4"-1"-1"	1 1/4"-1"-1 1/4"	1 1/4"-1 1/4"-1"	1 1/4"-1 1/2"-1"			
Siyah	151,00	162,00				162,00	162,00	162,00	162,00	227,00	227,00			
Galvaniz	189,00	205,00				205,00	205,00	205,00	205,00	286,00	286,00			
Ölçü	1 1/4"-1 1/2"-1 1/4"	1 1/2"-1/2"-1 1/2"				1 1/2"-3/4"-1 1/4"	1 1/2"-3/4"-1 1/2"	1 1/2"-1"-1 1/4"	1 1/2"-1"-1 1/2"	1 1/2"-1 1/4"-1 1/4"	1 1/2"-1 1/4"-1 1/2"			
Siyah	227,00	227,00				227,00	227,00	227,00	227,00	227,00	227,00			
Galvaniz	286,00	286,00				286,00	286,00	286,00	286,00	286,00	378,00			
Ölçü	2"-1/2"-2"	2"-3/4"-2"				2"-1"-1 1/2"	2"-1"-2"	2"-1 1/4"-1 1/2"	2"-1 1/4"-2"	2"-1 1/2"-2"	2"-2"-1"			
Siyah	302,00	302,00				302,00	302,00	302,00	302,00	302,00	303,00			
Galvaniz	378,00	378,00				378,00	378,00	378,00	378,00	379,00	744,00			
Ölçü	2 1/2"-1 1/4"-2 1/2"	2 1/2"-1 1/2"-2 1/2"				2 1/2"-2"-2 1/2"	3"-2"-3"							
Siyah	580,00	580,00				585,00	810,00							
Galvaniz	744,00	744,00				744,00	1.013,00							
180R	C1	İNEGAL KRUYA				Ölçü	3/4"-1/2"-1/2"-1/2"	3/4"-1/2"-3/4"-1/2"	1"-1/2"-3/4"-1/2"	1"-3/4"-3/4"-3/4"	1"-1/2"-1"-1/2"	1"-3/4"-1"-3/4"	1 1/4"-1/2"-1"-1/2"	1 1/4"-1/2"-1 1/4"-1/2"
						Siyah	136,00	136,00	270,00	270,00	270,00	270,00	320,00	320,00
						Galvaniz	171,00	171,00	340,00	340,00	340,00	340,00	400,00	400,00
						Ölçü	1 1/4"-3/4"-1"-3/4"	1 1/4"-3/4"-1 1/4"-3/4"	1 1/4"-1"-1 1/4"-1"	1 1/2"-1/2"-1 1/2"-1/2"	1 1/2"-3/4"-1 1/2"-3/4"	1 1/2"-1"-1 1/2"-1"	2"-1"-1 1/2"-1"	2"-1 1/4"-2"-1 1/4"
						Siyah	320,00	320,00	320,00	421,00	421,00	421,00	648,00	648,00
						Galvaniz	400,00	400,00	400,00	529,00	529,00	529,00	810,00	810,00
			Ölçü	2"-1 1/2"-2"-1 1/2"										
			Siyah	648,00										
			Galvaniz	810,00										
							90° REDÜKSİYON KUYRUKLU DIRSEK				Ölçü		3/4"x1/2"	
									92R		A4			
			90R	A1	DIRSEK REDÜKSİYON	Ölçü	3/4"-1/2"	1"-1/2"	1"-3/4"	1 1/4"-1/2"	1 1/4"-3/4"	1 1/4"-1"	1 1/2"-3/4"	1 1/2"-1"
Siyah	48,00	63,00				68,00	104,00	137,00	108,00	166,00	155,00			
Galvaniz	60,00	79,00				86,00	130,00	172,00	135,00	209,00	195,00			
Ölçü	1 1/2"-1 1/4"	2"-1"				2"-1 1/4"	2"-1 1/2"							
Siyah	173,00	272,00				290,00	280,00							
Galvaniz	217,00	340,00				367,00	351,00							
246	M4	MANŞON DİŞİÇİ VIDALI	Ölçü	3/4"-1/2"	1"-1/2"	1 1/2"-1"								
			Siyah	60,00	75,00	155,00								
			Galvaniz	75,00	94,00	194,00								
							POMPA BAĞLAMA		Ölçü		Ölçü			
						RAKORU (Somunlu)		1-1 1/2"		1 1/4"-2"				

01.02.2026

FLANŞLAR

DIN NORMU /EN 1092 - 1 NORMUNA UYGUN FLANŞ

Ölçü	DÜZ FLANŞ / ₺			
DN	PN10	PN16	PN 25	PN 40
15	₺184,62	₺184,62	₺184,62	₺184,62
20	₺210,26	₺210,26	₺210,26	₺210,26
25	₺246,15	₺246,15	₺246,15	₺246,15
32	₺338,46	₺338,46	₺338,46	₺338,46
40	₺384,62	₺384,62	₺384,62	₺384,62
50	₺512,82	₺512,82	₺512,82	₺512,82
65	₺641,03	₺641,03	₺769,23	₺769,23
80	₺748,72	₺748,72	₺948,72	₺948,72
100	₺820,51	₺820,51	₺1.230,77	₺1.230,77
125	₺1.010,26	₺1.010,26	₺1.820,51	₺1.820,51
150	₺1.435,90	₺1.435,90	₺2.128,21	₺2.128,21
200	₺1.856,41	₺1.856,41	₺3.333,33	₺3.820,51

Ölçü	KÖR-BORULU FLANŞ / ₺			
DN	PN10	PN16	PN 25	PN 40
15	₺307,69	₺307,69	₺307,69	₺184,62
20	₺333,33	₺333,33	₺333,33	₺210,26
25	₺410,26	₺410,26	₺410,26	₺246,15
32	₺487,18	₺487,18	₺487,18	₺338,46
40	₺538,46	₺538,46	₺538,46	₺384,62
50	₺666,67	₺666,67	₺717,95	₺512,82
65	₺794,87	₺794,87	₺1.005,13	₺769,23
80	₺1.025,64	₺1.025,64	₺1.271,79	₺948,72
100	₺1.128,21	₺1.128,21	₺1.743,59	₺1.230,77
125	₺1.435,90	₺1.435,90	₺2.512,82	₺1.820,51
150	₺1.923,08	₺1.923,08	₺3.128,21	₺2.128,21
200	₺2.820,51	₺2.820,51	₺4.615,38	₺3.820,51

DIN NORMUNA UYGUN FLANŞ

Ölçü	DÜZ FLANŞ/₺			
DN	PN10	PN16	PN 25	PN 40
250	₺3.179,49	₺3.302,56	₺4.871,79	₺5.384,62
300	₺3.897,44	₺4.061,54	₺6.769,23	₺8.543,59
350	₺5.158,97	₺5.600,00	₺9.579,49	₺10.564,10
400	₺5.948,72	₺7.102,56	₺12.923,08	₺15.487,18
450	₺8.307,69	₺8.717,95	₺14.615,38	₺18.871,79
500	₺9.743,59	₺10.789,74	₺17.179,49	₺20.512,82
600	₺11.794,87	₺15.179,49	₺22.153,85	₺25.641,03

Ölçü	KÖR-BORULU FLANŞ/₺			
DN	PN10	PN16	PN 25	PN 40
250	₺4.717,95	₺5.435,90	₺7.692,31	₺5.384,62
300	₺6.666,67	₺7.487,18	₺10.256,41	₺8.543,59
350	₺8.205,13	₺9.538,46	₺15.384,62	₺10.564,10
400	₺10.666,67	₺13.333,33	₺20.512,82	₺15.487,18
450	₺11.282,05	₺14.153,85	₺23.794,87	₺18.871,79
500	₺16.410,26	₺20.512,82	₺29.743,59	₺20.512,82
600	₺22.051,28	₺26.410,26	Fiyat İsteyiniz	₺25.641,03

01.02.2026

FLANŞLAR

DIN NORMUNA UYGUN FLANŞ

ÖLÇÜ	KAYNAK BOYUNLU FLANŞ			
DN	PN10	PN16	PN 25	PN 40
15	₺338,46	₺338,46	₺338,46	₺338,46
20	₺389,74	₺389,74	₺389,74	₺389,74
25	₺461,54	₺461,54	₺461,54	₺461,54
32	₺578,46	₺578,46	₺578,46	₺578,46
40	₺713,85	₺713,85	₺713,85	₺713,85
50	₺851,28	₺851,28	₺933,33	₺933,33
65	₺984,62	₺984,62	₺1.087,18	₺1.087,18
80	₺1.292,31	₺1.292,31	₺1.425,64	₺1.425,64
100	₺1.702,56	₺1.702,56	₺1.866,67	₺1.866,67
125	₺1.860,51	₺1.860,51	₺2.580,51	₺2.580,51
150	₺2.338,46	₺2.338,46	₺3.261,54	₺3.261,54
200	₺3.805,13	₺3.805,13	Fiyat isteyiniz	Fiyat isteyiniz

01.02.2026

PATENT DİRSEK



ÖLÇÜSÜ		DIN 2605			ANSI B 16,9	
mm	NW	İNCH	DİKİŞLİ (t) /ADET	DİKİŞSİZ (t) /ADET	mm	SCH 40
21,3 X 2,0	15	1/2	₺28,72	₺49,23	2,7	-
26,9 X 2,3	20	3/4	₺28,72	₺49,23	3,2	-
33,7 X 2,6	25	1	₺31,79	₺63,59	3,4	₺63,59
42,4 X 2,6	32	1 1/4	₺46,15	₺65,64	3,6	₺65,64
48,3 X 2,6	40	1 1/2	₺57,44	₺86,15	3,6	₺86,15
60,3 X 2,9	50	2	₺73,85	₺134,36	4	₺134,36
76,1 X 2,9	65	2 1/2	₺128,21	₺226,67	5	₺253,33
88,9 X 3,2	80	3	₺169,23	₺336,41	5,5	₺370,26
114,3 X 3,6	100	4	₺312,82	₺618,46	6,2	₺682,05
139,7 X 4,0	125	5	₺543,59	₺1.007,18	6,3	₺1.107,69
168,3 X 4,5	150	6	₺754,87	₺1.581,54	7,1	₺1.743,59
219,1 X 4,5	200	8	₺1.481,03	₺3.308,72	8,2	₺3.649,23
273,0 X 6,3	250	10	₺3.958,97	₺5.815,38	9,3	₺6.410,26
323,9 X 7,1	300	12	-	-	9,5	-
355,6 X 8,0	350	14	-	-	9,5	-
406,4 X 8,8	400	16	-	-	9,5	-
457,2 X 8,8	450	18	-	-	9,5	-
508,0 X 10	500	20	-	-	10	-
609,6 X 10	600	24	-	-	10	-

01.02.2026

MANŞON



ANMA ÖLÇÜSÜ		DIŞ ÇAP	BOY	YARIM MANŞON	PAKET	GALVANİZ	SİYAH
mm	inch	D 2min	L mm min	Boy	Adet	adet/₺	adet/₺
DN 6	1/8"	15,00 mm	19 mm	8,0 mm	1000	₺62,00	₺60,00
DN 8	1/4"	18,5 mm	27 mm	11 mm	1000	₺62,00	₺60,00
DN 10	3/8"	22,0 mm	28 mm	12 mm	1000	₺52,00	₺48,00
DN 15	1/2"	27,0 mm	37 mm	16 mm	400	₺28,00	₺24,00
DN 20	3/4"	32,5 mm	39 mm	19 mm	250	₺36,00	₺32,00
DN 25	1"	39,5 mm	46 mm	21 mm	150	₺56,00	₺48,00
DN 32	1 1/4"	49,0 mm	51 mm	25 mm	100	₺80,00	₺74,00
DN 40	1 1/2"	56,0 mm	51 mm	25 mm	80	₺96,00	₺86,00
DN 50	2"	68,0 mm	60 mm	28 mm	60	₺140,00	₺128,00
DN 65	2 1/2"	84,0 mm	69 mm	30 mm	40	₺240,00	₺200,00
DN 80	3"	98,0 mm	75 mm	35 mm	30	₺288,00	₺240,00
DN 100	4"	124,4 mm	87 mm	40 mm	15	₺480,00	₺392,00
DN 125	5"	151,0 mm	96 mm	44 mm	10	₺840,00	₺760,00
DN 150	6"	178,0 mm	93 mm	44 mm	10	₺920,00	₺800,00

01.02.2026

PATENT EK PARÇALAR

TSE 2649- 10253-1



KEP	
ÖLÇÜ	FİYAT (₺)
1/2"	₺44,79
3/4"	₺51,19
1"	₺76,20
1 1/4"	₺89,41
1 1/2"	₺91,44
2"	₺97,52
2 1/2"	₺120,33
3"	₺131,41
4"	₺191,99
5"	₺310,01
6"	₺455,83
8"	₺932,58
10"	₺1.310,40
12"	₺1.794,13
14"	₺3.075,26
16"	₺4.074,68
18"	₺4.298,21
20"	₺4.645,03

01.02.2026

PATENT EK PARÇALARI

KONSANTRİK REDÜKSİYON

ÖLÇÜ	FİYAT (₺)	ÖLÇÜ	FİYAT (₺)
3/4"1/2	₺37,84	4"2	₺319,92
1"3/4	₺37,84	4"11/2	₺392,85
1"1/2	₺39,56	5"4	₺395,60
11/4"1	₺51,60	5"3	₺445,17
11/4"3/4	₺61,92	5"21/2	₺502,24
11/4"1/2	₺75,68	5"2	₺689,72
11/2"11/4	₺58,48	6"5	₺602,00
11/2"1	₺61,92	6"4	₺652,22
11/2"3/4	₺82,56	6"3	₺791,89
11/2"1/2	₺106,64	6"21/2	₺964,23
2"11/2	₺72,24	6"2	₺1.211,12
2"11/4	₺89,44	8"6	₺911,60
2"1	₺99,76	8"5	₺997,60
2"3/4	₺116,96	8"4	₺1.208,78
21/2"2	₺106,64	8"3	₺1.685,60
21/2"11/2	₺127,28	10"8	₺1.551,41
21/2"11/4	₺144,48	10"6	₺1.834,45
21/2"1	₺164,16	10"5	₺2.054,57
3"21/2	₺137,60	10"4	₺2.545,60
3"2	₺165,12	12"10	₺2.084,67
3"11/2	₺189,20	12"8	₺2.452,55
3"11/4	₺240,80	12"6	₺2.958,40
3"1	₺275,20	14"12	₺6.192,00
4"3	₺247,78	14"10	₺6.295,20
4"21/2	₺271,38	14"8	₺6.673,60

01.02.2026

PATENT EK PARÇALARI

KAYNAKLI DÜZ KRUYA

ÖLÇÜ	FİYAT (₺)
1"	₺153,08
1 1/4"	₺227,73
1 1/2"	₺250,71
2"	₺423,12
2 1/2"	₺644,83
3"	₺892,03
4"	₺1.159,28

İNİEGAL KRUYA 2"

ÖLÇÜ	FİYAT (₺)
2 1/2"2"2"2	₺509,12
2 1/2"2"2 1/2"2	₺464,40
3"2"2 1/2"2	₺832,48
3"2"3"2	₺715,52
4"2"3"2	₺1.052,64
4"2"4"2	₺918,48

İNİEGAL KRUYA 1 1/4"

ÖLÇÜ	FİYAT (₺)
1 1/2"1 1/4"1 1/2"1 1/4" /4	₺237,64
2"1 1/4"2"1 1/4"	₺275,20
2 1/2"1 1/4"2"1 1/4"	₺416,24
2 1/2"1 1/4"2 1/2"1 1/4" /4	₺392,16
3"1 1/4"2 1/2"1 1/4"	₺825,60
4"1 1/4"4"1 1/4"	₺768,84

DÜZ KRUYA 1"

ÖLÇÜ	FİYAT (₺)
1 1/4"1"1"1	₺203,58
1 1/4"1"1 1/4"1	₺198,11
1 1/2"1"1"1	₺237,91
1 1/2"1"1 1/4"1	₺217,51
1 1/2"1"1 1/2"1	₺206,09
2"1"1 1/2"1	₺294,98
2"1"2"1	₺251,84
2 1/2"1"2"1	₺474,72
2 1/2"1"2 1/2"1	₺412,80
3"1"2 1/2"1	₺825,60
3"1"3"1	₺739,60
4"1"4"1	₺722,40

İNİEGAL KRUYA 1 1/2"

ÖLÇÜ	FİYAT (₺)
2"1 1/2"1 1/2"1 1/2"	₺344,00
2"1 1/2"2"1 1/2"	₺292,40
2 1/2"1 1/2"2"1 1/2"	₺430,00
2 1/2"1 1/2"2 1/2"1 1/2"	₺395,60
3"1 1/2"2 1/2"1 1/2"	₺877,20
3"1 1/2"3"1 1/2"	₺736,16
4"1 1/2"3"1 1/2"	₺951,85
4"1 1/2"4"1 1/2"	₺818,34

İNİEGAL KRUYA 2 1/2"

ÖLÇÜ	FİYAT (₺)
3"2 1/2"2 1/2"2 1/2"	₺739,60
3"2 1/2"3"2 1/2"	₺791,20
4"2 1/2"3"2 1/2"	₺1.269,36
4"2 1/2"4"2 1/2"	₺1.090,48

01.02.2026

PATENT EK PARÇALARI

DÜZ TE

ÖLÇÜ	FİYAT (₺)
1/2"	₺96,32
3/4"	₺99,76
1"	₺103,20
1 1/4"	₺134,16
1 1/2"	₺159,96
2"	₺227,04
2 1/2"	₺361,20
3"	₺584,80
4"	₺980,40
5"	₺1.334,72
6"	₺2.029,60
8"	₺3.096,00
10"	₺5.091,20
12"	₺6.536,00

İNEĞAL TE 1/2"

ÖLÇÜ	FİYAT (₺)
3/4"1/2"1/2	₺137,60
3/4"1/2"3/4	₺134,16
1"1/2"3/4	₺172,00
1"1/2"1"	₺144,48

İNEĞAL TE 3/4"

ÖLÇÜ	FİYAT (₺)
1/2"3/4"1/2	₺182,32
3/4"3/4"1/2	₺154,80
1"3/4"1/2	₺154,80
1"3/4"3/4	₺122,46
1"3/4"1"	₺110,08
1 1/4"3/4"3/4	₺289,82
1 1/4"3/4"1"	₺238,91
1 1/4"3/4"1 1/4"	₺219,85
1 1/2"3/4"1 1/4"	₺359,07
1 1/2"3/4"1 1/2"	₺332,72
2"3/4"1 1/2"	₺371,52
2"3/4"2"	₺310,25
2 1/2"3/4"2"	₺423,12
2 1/2"3/4"2 1/2"	₺405,92
3"3/4"2 1/2"	₺653,60
3"3/4"3"	₺612,32

İNEĞAL TE 1"

ÖLÇÜ	FİYAT (₺)
3/4"1"1/2	₺144,48
3/4"1"3/4	₺130,72
1"1"3/4	₺124,22
1 1/4"1"	₺161,68
1 1/4"1"1/4"	₺141,04
1 1/2"1"	₺240,80
1 1/2"1"1/4"	₺196,08
1 1/2"1"1/2"	₺175,44
2"1"	₺401,10
2"1"2"	₺240,80
2"1"1 1/4"	₺344,00
2"1"1 1/2"	₺308,22
2 1/2"1"1 1/2"	₺498,80
2 1/2"1"1 1/4"	₺447,20
2 1/2"1"2"	₺405,92
2 1/2"1"2 1/2"	₺366,02
3"1"2 1/2"	₺670,80
3"1"3"	₺619,20
4"1"3"	₺825,94
4"1"4"	₺747,17

İNEĞAL TE 1 1/2"

ÖLÇÜ	FİYAT (₺)
1 1/2"1"	₺292,40
1 1/4"1"2"1 1/4"	₺318,03
1 1/2"1"2"1"	₺244,24
1 1/2"1"2"1 1/4"	₺223,60
2"1"2"1"	₺412,80
2"1"2"1 1/4"	₺361,20
2"1"2"1 1/2"	₺324,29
2"1"2"2"	₺273,62
2 1/2"1"2"1 1/2"	₺529,76
2 1/2"1"2"2"	₺412,80
2 1/2"1"2"2 1/2"	₺402,48
3"1"2"2 1/2"	₺652,40
3"1"2"3"	₺636,40
4"1"2"3"	₺759,31
4"1"2"4"	₺809,71

İNEĞAL TE 2"

ÖLÇÜ	FİYAT (₺)
1 1/2"2"1 1/2"	₺447,20
2"2"1"	₺395,60
2"2"1 1/4"	₺319,92
2"2"1 1/2"	₺288,96
2 1/2"2"1 1/2"	₺481,60
2 1/2"2"2"	₺443,76
2 1/2"2"2 1/2"	₺395,60
3"2"2 1/2"	₺670,80
3"2"3"	₺619,20
4"2"3"	₺1.221,20
4"2"4"	₺1.083,60

İNEĞAL TE 2 1/2"

ÖLÇÜ	FİYAT (₺)
2 1/2"2 1/2"2"	₺509,12
3"2 1/2"2 1/2"	₺670,80
3"2 1/2"3"	₺619,20
4"2 1/2"3"	₺1.145,52
4"2 1/2"4"	₺966,64

İNEĞAL TE 1 1/4"

ÖLÇÜ	FİYAT (₺)
3/4"1 1/4"3/4"	₺223,60
1"1 1/4"3/4"	₺223,60
1"1 1/4"1"	₺196,08
1 1/4"1 1/4"1"	₺165,12
1 1/2"1 1/4"1"	₺244,24
1 1/2"1 1/4"1 1/4"	₺220,16
1 1/2"1 1/4"1 1/2"	₺178,88
2"1 1/4"1"	₺344,00
2"1 1/4"1 1/4"	₺318,37
2"1 1/4"1 1/2"	₺275,20
2"1 1/4"2"	₺261,44
2 1/2"1 1/4"1 1/4"	₺430,00
2 1/2"1 1/4"1 1/2"	₺516,00
2 1/2"1 1/4"2"	₺405,92
2 1/2"1 1/4"2 1/2"	₺385,28
3"1 1/4"2 1/2"	₺669,22
3"1 1/4"3"	₺612,32
4"1 1/4"3"	₺881,02
4"1 1/4"4"	₺710,02

01.02.2026

KELEPÇELER

SOMUNLU KELEPÇE				
ÜRÜN KODU	SIKMA ARALIĞI (mm)	ÖLÇÜ	FİYAT/TL	KOLİ İÇİ ADET
FMSM 050	21-26	1/2"	€19,20	200
FMSM 075	26-30	3/4"	€20,79	175
FMSM 100	33-37	1"	€23,38	150
FMSM 125	40-46	1 1/4"	€28,22	100
FMSM 150	48-53	1 1/2"	€30,77	80
FMSM 200	60-66	2"	€34,62	60
FMSM 250	75-84	2 1/2"	€60,23	60
FMSM 300	87-96	3"	€66,66	50
FMSM 350	102-111	3 1/2"	€74,36	50
FMSM 400	109-119	4"	€79,70	40
FMSM 450	122-135	4 1/2"	€106,87	40
FMSM 500	135-148	5"	€112,81	25
FMSM 550	151-164	5 1/2"	€126,78	25
FMSM 600	158-170	6"	€131,34	20
FMSM 700	194-205	7"	€154,00	15
FMSM 800	214-224	8"	€163,90	15
FMSM 1000	269-275	10"	€187,92	15

STANDART TRİFONLU KELEPÇE				
ÜRÜN KODU	SIKMA ARALIĞI (mm)	ÖLÇÜ	FİYAT/TL	KOLİ İÇİ ADET
FMST 050	21-26	1/2"	€20,79	150
FMST 075	26-30	3/4"	€23,07	125
FMST 100	33-37	1"	€25,29	100
FMST 125	40-46	1 1/4"	€31,42	75
FMST 150	48-53	1 1/2"	€33,96	60
FMST 200	60-66	2"	€37,82	50
FMST 250	75-84	2 1/2"	€62,21	35
FMST 300	87-96	3"	€69,25	30
FMST 350	102-111	3 1/2"	€79,48	25
FMST 400	109-119	4"	€86,08	20
FMST 450	122-135	4 1/2"	€109,18	20
FMST 500	135-148	5"	€121,88	15
FMST 550	151-164	5 1/2"	€130,52	10
FMST 600	158-170	6"	€143,22	10
FMST 700	194-205	7"	€159,50	10
FMST 800	214-224	8"	€180,40	10
FMST 1000	269-275	10"	€217,92	5

UZUN TRİFONLU KELEPÇE				
ÜRÜN KODU	SIKMA ARALIĞI (mm)	ÖLÇÜ	FİYAT/TL	KOLİ İÇİ ADET
FMUT 050	21-26	1/2"	€24,26	150
FMUT 075	26-30	3/4"	€25,98	100
FMUT 100	33-37	1"	€28,18	80
FMUT 125	40-46	1 1/4"	€34,62	70
FMUT 150	48-53	1 1/2"	€37,19	50
FMUT 200	60-66	2"	€42,31	40
FMUT 250	75-84	2 1/2"	€64,13	30
FMUT 300	87-96	3"	€83,33	25
FMUT 350	102-111	3 1/2"	€86,63	20
FMUT 400	109-119	4"	€92,97	20
FMUT 450	122-135	4 1/2"	€112,20	15
FMUT 500	135-148	5"	€129,53	10
FMUT 550	151-164	5 1/2"	€147,57	10
FMUT 600	158-170	6"	€157,65	10
FMUT 700	194-205	7"	€173,25	10
FMUT 800	214-224	8"	€192,50	10
FMUT 1000	269-275	10"	€237,92	5

SPRİNG (ARMUT) KELEPÇE				
ÜRÜN KODU	SIKMA ARALIĞI (mm)	ÖLÇÜ	FİYAT/TL	KOLİ İÇİ ADET
F MSP 050	21-26	1/2"	€13,86	150
F MSP 075	26-30	3/4"	€15,36	125
F MSP 100	33-37	1"	€17,00	100
F MSP 125	40-46	1 1/4"	€22,75	75
F MSP 150	48-53	1 1/2"	€23,73	60
F MSP 200	60-66	2"	€26,91	50
F MSP 250	75-84	2 1/2"	€41,00	35
F MSP 300	87-96	3"	€46,77	30
F MSP 400	109-119	4"	€70,73	20
F MSP 500	135-148	5"	€96,14	15
F MSP 600	158-170	6"	€114,13	10
F MSP 800	214-224	8"	€262,79	10
F MSP 1000	269-275	10"	€314,16	10
F MSP 1200	308-324	12"	€404,25	10
F MSP 1400	340-356	14"	€492,80	10
F MSP 1600	393-409	16"	€620,40	10

AĞIR YÜK KAFALI KELEPÇE				
ÜRÜN KODU	SIKMA ARALIĞI (mm)	ÖLÇÜ	FİYAT/TL	KOLİ İÇİ ADET
F MAY 050	21-26	1/2"	€65,40	50
F MAY 075	26-30	3/4"	€69,25	50
F MAY 100	33-37	1"	€73,70	50
F MAY 125	40-46	1 1/4"	€79,53	40
F MAY 150	48-53	1 1/2"	€85,80	40
F MAY 200	60-66	2"	€90,37	30
F MAY 250	75-84	2 1/2"	€105,11	25
F MAY 300	87-96	3"	€112,90	30
F MAY 400	109-119	4"	€160,27	25
F MAY 500	135-148	5"	€246,18	10
F MAY 600	158-170	6"	€269,17	10
F MAY 800	214-224	8"	€371,91	10
F MAY 1000	269-275	10"	€467,78	10
F MAY 1200	308-324	12"	€864,60	10
F MAY 1400	340-356	14"	€961,40	8
F MAY 1600	393-409	16"	€1.601,60	5
F MAY 1800	444-460	18"	€1.859,00	5
F MAY 2000	497-512	20"	€2.051,50	5

AĞIR YÜK SOMUNLU KELEPÇE				
ÜRÜN KODU	SIKMA ARALIĞI (mm)	ÖLÇÜ	FİYAT/TL	KOLİ İÇİ ADET
F MAS 050	21-26	1/2"	€61,49	50
F MAS 075	26-30	3/4"	€64,10	50
F MAS 100	33-37	1"	€70,46	50
F MAS 125	40-46	1 1/4"	€75,65	50
F MAS 150	48-53	1 1/2"	€82,35	50
F MAS 200	60-66	2"	€88,47	50
F MAS 250	75-84	2 1/2"	€96,15	30
F MAS 300	87-96	3"	€108,97	25
F MAS 400	109-119	4"	€147,40	25
F MAS 500	135-148	5"	€243,65	15
F MAS 600	158-170	6"	€262,79	15
F MAS 800	214-224	8"	€365,39	5
F MAS 1000	269-275	10"	€442,31	5
F MAS 1200	308-324	12"	€833,25	5
F MAS 1400	340-356	14"	€929,50	5
F MAS 1600	393-409	16"	€1.602,70	5
F MAS 1800	444-460	18"	€1.795,20	5
F MAS 2000	497-512	20"	€1.922,80	5



SESSİZ KELEPÇELER



SESSİZ SOMUNLU KELEPÇE				
ÜRÜN KODU	SIKMA ARALIĞI (mm)	ÖLÇÜ	FİYAT/TL	KOLİ İÇİ ADET
F MSS 150	49-51	1 1/2"	€73,98	50
F MSS 250	70-76	2 1/2"	€108,63	25
F MSS 400	106-114	4"	€154,83	20
F MSS 450	124-130	4 1/2"	€191,73	15
F MSS 600	155-162	6"	€249,48	10
F MSS 700	191-200	7"	€274,89	5
F MSS 800	214-224	8"	€294,53	5

AKUSTİK KELEPÇE				
ÜRÜN KODU	SIKMA ARALIĞI (mm)	ÖLÇÜ	FİYAT/TL	KOLİ İÇİ ADET
F MSSZ 150	49-51	1 1/2"	€71,61	50
F MSSZ 250	70-76	2 1/2"	€106,26	25
F MSSZ 400	106-114	4"	€153,62	20
F MSSZ 450	124-130	4 1/2"	€188,27	15
F MSSZ 600	155-162	6"	€242,55	10
F MSSZ 700	191-200	7"	€269,12	5
F MSSZ 800	214-224	8"	€288,75	5

SESSİZ TRİFONLU KELEPÇE				
ÜRÜN KODU	SIKMA ARALIĞI (mm)	ÖLÇÜ	FİYAT/TL	KOLİ İÇİ ADET
F MSSST 150	49-51	1 1/2"	€75,08	30
F MSSST 250	70-76	2 1/2"	€109,73	20
F MSSST 400	106-114	4"	€157,08	10
F MSSST 450	124-130	4 1/2"	€198,66	10
F MSSST 600	155-162	6"	€262,19	5
F MSSST 700	191-200	7"	€288,75	5
F MSSST 800	214-224	8"	€300,30	5



01.02.2026

KELEPÇELER

	ÖLÇÜ	1/8"	1/4"	3/8"	1/2"	3/4"	1"	1 1/4"	1 1/2"	2"	2 1/2"	3"	4"	5"	6"	8"	10"	12"	14"	16"	18"	20"	
SOMUNLU KELEPÇE	FİYAT	18,62	18,62	18,62	18,62	20,19	22,63	27,46	29,94	33,90	58,39	64,61	76,64	109,20	126,80	158,66							
	ADET / KOLİ	300	250	250	200	150	150	100	75	50	40	40	30	25	20	15							
KOMBİ SOMUNLU KELEPÇE (M8-M10)	FİYAT	23,78	23,78	23,78	23,78	25,49	27,64	33,31	35,36	39,59	61,64	68,39	81,20	114,52	132,62	165,97							
	ADET / KOLİ	250	250	250	200	150	100	100	75	50	40	40	30	25	20	15							
TRİFONLU KELEPÇE	FİYAT	19,79	19,79	20,29	20,86	22,56	24,42	30,24	32,68	36,62	59,54	66,97	81,62	119,01									
	ADET / KOLİ	200	200	150	150	125	100	75	50	50	25	20	15	10									
UZUN TRİFONLU KELEPÇE	FİYAT	23,59	23,59	23,59	23,59	25,28	27,12	33,46	35,69	40,70	62,99	78,28	86,01										
	ADET / KOLİ	150	150	150	150	100	75	50	50	40	20	20	15										
SPRİNKLER KELEPÇE	FİYAT				14,20	15,07	16,01	21,91	22,76	25,91	39,53	45,08	67,79	94,99	110,49	258,42	306,83	389,66					
	ADET / KOLİ				150	125	100	75	60	50	35	25	30	30	30	10	15	10					
SPRİNKLER KELEPÇE (UZUN)	FİYAT				24,76	26,07	28,62	32,67	34,86	39,55	70,86	81,74	95,71	141,76	163,36	394,21	493,47						
	ADET / KOLİ				100	100	75	50	50	40	30	25	30	25	20	10	10						
AĞIR YÜK SOMUNLU KELEPÇE	FİYAT				59,44	62,27	67,52	73,19	79,34	85,23	94,22	100,71	142,61	233,92	255,13	354,32	432,21	769,34	851,53	1.570,86	1.754,69	1.827,15	
	ADET / KOLİ				50	50	50	50	50	40	30	30	30	10	10	15	15	10	10	5	5	4	
AĞIR YÜK KAFALI KELEPÇE	FİYAT				63,27	66,66	71,32	77,04	83,10	89,39	98,94	104,97	154,59	240,47	262,03	364,09	452,00	809,86	882,93	1.641,83	1.824,22	1.996,69	
	ADET / KOLİ				50	50	50	40	40	30	25	30	25	10	10	15	15	10	8	5	5	4	

PVC KELEPÇE	ÖLÇÜ	50	75	100	125	150	200	POLİÜRETAN İZOLASYON TAKOZU	PASLANMAZ KELEPÇE (SOMUNLU - AĞIR YÜK KAFALI TRİFONLU)				
	FİYAT	30,41	57,90	79,78	101,93	121,81	156,80						
ADET / KOLİ	75	50	30	25	20	10							
		53-59	67-77	83-93	94-104	102-111	122-135	128-139	151-164	194-205	240-250	380-390	
SOMUNLU KELEPÇE	FİYAT	36,17	55,53	62,41	74,26	77,65	105,35	108,00	125,83	159,10			
	ADET / KOLİ	75	40	40	30	40	30	30	25	15			
KOMBİ SOMUNLU KELEPÇE (M8-M10)	FİYAT	42,14	58,37	64,26	79,83	82,83	111,87	114,90	132,22	166,56			
	ADET / KOLİ	75	40	40	30	40	30	30	25	15			
TRİFONLU KELEPÇE	FİYAT	37,82	56,79	63,41	75,42	81,41	107,52		130,10				
	ADET / KOLİ	50	20	25	20	15	15		15				
UZUN TRİFONLU KELEPÇE	FİYAT	38,91	58,70	65,96	78,94	84,96	110,52						
	ADET / KOLİ	50	25	20	15	15	15						
AĞIR YÜK SOMUNLU KELEPÇE	FİYAT	84,21	92,85	104,54	134,26	134,26	219,69	219,69	239,70	332,79	405,74	1.508,18	
	ADET / KOLİ	40	40	30	30	30	20	10	10	20	15	5	
AĞIR YÜK KAFALI KELEPÇE	FİYAT	87,23	101,70	113,34	141,72	141,72	219,69	219,69	239,72	332,79	405,75	1.547,29	
	ADET / KOLİ	30	25	30	25	25	10	10	10	20	15	5	

Lastiksiz ürünlerin Üste fiyatı için, lastikli ürünlerin fiyatlarından %15 düşünüz.

SESSİZ KELEPÇE	ÖLÇÜ	50	75	110	125	160	200
	SOMUNLU	66,00	105,09	129,56	168,67	204,28	225,17
ADET / KOLİ	75	40	25	25	15	10	
TRİFONLU	FİYAT	69,92	104,15	133,12			
	ADET / KOLİ	75	40	25			
ÜST KELEPÇE	FİYAT	58,66	96,50	122,63	162,23	197,16	215,40
	ADET / KOLİ	75	40	25	25	15	10

KAYAR MESNET	ÖLÇÜ	30x40x2x200	30x40x2x250	50x50x3x250
	FİYAT	277,81	317,26	686,62
ADET / KOLİ	10	10	10	

KAYAR YATAK	ÖLÇÜ	KÜÇÜK TİP	BÜYÜK TİP
	FİYAT	261,30	617,17
ADET / KOLİ	20	10	

HAVALANDIRMA KELEPÇESİ	ÖLÇÜ	71	80	90	100	112	125	140	150	160	180	200	224	250	280	300	315	355	400	450	500
	FİYAT	71,40	75,18	78,65	81,09	84,47	87,43	102,13	110,51	119,83	133,60	139,66	205,76	237,95	261,06	280,54	292,96	308,97	382,47	431,48	563,52
ADET / KOLİ	40	35	35	35	35	35	30	30	30	25	20	15	20	20	20	20	20	20	15	10	
ÖLÇÜ	560	600	630	710	800	900	1000	1120	1250	1400											
	FİYAT	595,32	638,52	702,09	740,85	820,43	912,37	998,58	1.109,88	1.222,94	1.423,47										
ADET / KOLİ	10	10	10	10	10	10	10	10	10	10											

BACA KELEPÇESİ	ÖLÇÜ	83	92	100	105	111	121	125	131	139	150	160	170	180	200	220	250	300	350	400
	FİYAT	59,01	61,79	64,98	66,84	68,79	73,00	87,13	92,51	93,15	107,63	113,68	120,15	126,39	136,11	142,49	148,34	170,82	190,00	215,49
ADET / KOLİ	35	35	35	35	35	35	35	30	30	30	30	25	25	20	20	20	20	20	20	

KARE KELEPÇE		Trifonlu	Trifonsuz
	FİYAT	46,87	26,19
ADET / KOLİ	25	75	

SOLAR KELEPÇE	ÖLÇÜ	34x80	38x94	44x115	48x125
	FİYAT	63,06	69,85	84,00	95,55
ADET / KOLİ	100	75	50	50	

01.02.2026

KELEPÇELER

PERFORE KANAL	C	ÖLÇÜ	27x18x1,20x4000	28x30x1,50x4000	40x38x1,80x4000																
		FİYAT	348,68	591,62	984,16																
	L	ÖLÇÜ	30x30x2x2000	30x30x2,5x2000	30x30x3x2000	40x40x2,5x2000	40x40x3x2000	40x40x4x2000	50x50x3x2000	50x50x4x2000											
		FİYAT	230,35	280,95	326,92	356,55	425,16	557,88	578,13	725,47											
	U	ÖLÇÜ	30x30x2x2000	30x30x2,5x2000	30x30x3x2000	40x40x2,5x2000	40x40x3x2000	40x40x4x2000	50x50x3x2000	50x50x4x2000											
		FİYAT	348,68	386,92	474,65	535,38	646,96	841,55	854,82	1.086,52											
	6	ÖLÇÜ	41x21x2	41x41x2	41x41x2,5	41x62x2,5															
		FİYAT	Fiyat Sorunuz	Fiyat Sorunuz	Fiyat Sorunuz	Fiyat Sorunuz															
											G KANAL BAĞLANTI PARÇALARI İÇİN										
																					FİYAT SORUNUZ

	ÖLÇÜ	M6		M8		M10				M12			M16				M20						
		45	65	55	75	70	85	90	110	150	90	110	150	110	120	145	180	200	140	150	180	200	
SAÇ GÖMLEKLI DÜBEL	FİYAT			7,77	10,36	14,82	16,79		21,07	28,60	33,57												
KLİPSLİ DÜBEL	FİYAT			12,00				16,33	19,11	23,15		24,54	31,95	45,73	51,75	62,32			156,28	170,17	187,54		
BORULU DÜBEL	FİYAT			19,00		25,20		31,49		35,66	40,98			82,19					219,95				

	ÖLÇÜ	M6	M7	M8	M10	M12	M14	M16	UZATMA SOMUNU	ÖLÇÜ	M6x30x11	M8x40x13	M10x40x15	M12x40x17	M16x40x17	
		FİYAT	5,10		4,95	8,25	21,00	55,00		FİYAT	17,70	19,50	25,90	31,00	50,00	
ÇAKMALI DÜBEL	FİYAT	9,00		5,35	8,80	18,00	360,00		TRİFON ADAPTÖRÜ	ÖLÇÜ	M8x80	M8x100	M8x120	M10x100	M10x120	M10x150
ÇEKME Lİ DÜBEL (S TİPİ)	FİYAT			0,37	0,54	1,18			FİYAT	5,20	6,50	8,15	8,50	9,80	17,20	
PLASTİK DÜBEL	FİYAT	18,30		25,40	38,00				VİBRASYON TAKOZU	ÖLÇÜ	M8	M10				
KANCALI GÖMLEKLI DÜBEL	FİYAT								FİYAT	12,20	33,00					

ROT (TİJ)	ÖLÇÜ	M6		M8		M10		M12		M14		M16		M18		M20		M22		M24	
		1000	2000	1000	2000	1000	2000	1000	2000	1000	2000	1000	2000	1000	2000	1000	2000	1000	2000	1000	2000
	FİYAT	25,00	50,00	33,00	66,00	53,00	106,00	76,50	153,00	108,00	216,00	148,00	296,00	185,00	370,00	234,00	468,00	288,40	576,80	339,90	679,80
	ÖLÇÜ	M27		M30																	
1000		2000	1000	2000																	
FİYAT	442,90	885,80	545,90																		

NOT: 3000'lik Rodlar için fiyat sorunuz

U BOLT	ÖLÇÜ	1/2"	3/4"	1"	1 1/4"	1 1/2"	2"	2 1/2"	3"	3 1/2"	4"	5"	6"	8"	10"	12"	14"	16"	18"	20"	24"
	FİYAT	7,88	8,28	12,77	14,67	16,05	27,15	31,50	54,00	57,00	64,00	71,50	147,00	178,00	210,00	264,00	350,00	510,00	580,00	980,00	1.120,00

ASKI MENGESİ	ÖLÇÜ	M6-M8	M8-M10
	FİYAT	84,62	129,54
	ADET / KOLİ	100	50

G - KLİPS (SIKIŞTIRMA PARÇASI)	FİYAT	6,50
	ADET / KOLİ	300

KAYAR PABUÇ	
	FİYAT SORUNUZ

NEOPREN CONTA	
	FİYAT SORUNUZ

ÇİVATA, SOMUN, PUL ÇEŞİTLERİMİZ MEVCUTTUR.	
	FİYAT SORUNUZ

FLANŞLI VANA VE ELEMANLARI

FİYAT LİSTESİ

01.02.2026

FAF 1100

KÜRESEL VANA - TG - PN10-16 2 PARÇALI



ÜRÜN ÖZELLİKLERİ	ÇAP		FAF1100
	MM	İNÇ	FİYAT \$
<ul style="list-style-type: none"> Tam geçişlidir. Flanşlar ve gövde GG25 pik dökümdür. Paslanmaz çelik kürelidir. Paslanmaz çelik tabak yay takviyelidir. Sızdırmazlık elemanı (PTFE) teflondur. Maksimum çalışma sıcaklığı 200°C'dir. 15-150 çapları arası F4, 200-250-300 çaplarında F5 montaj boyundadır. * DN 300 Redüksiyon geçişlidir. 	15	1/2"	96
	20	3/4"	97
	25	1"	102
	32	1 1/4"	107
	40	1 1/2"	113
	50	2"	133
	65	2 1/2"	163
	80	3"	211
	100	4"	275
	125	5"	452
	150	6"	624
	200	8"	1486
	250	10"	2367
300*	12"	3190	

FAF 3700K

DİŞLİ KUTUSU - KÜRESEL VANA UYGULAMASI

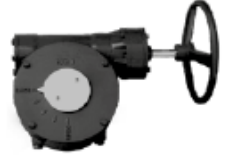

ÜRÜN ÖZELLİKLERİ	ÇAP		FAF3700K
	MM	İNÇ	FİYAT \$
<ul style="list-style-type: none"> Vana için dişli kutusu seçerken bağlantı ölçülerine ve dişli kutusu oranına dikkat edilmelidir. Dişli kutusu seçimi yapılırken FAF Vana teknik ekibinden destek alınması tavsiye edilir. Verilen fiyatlar 1200 ve 1400 serisi küresel vanaların uygulaması için oluşturulmuştur. * 3700K dişli kutusu fiyatlarına adaptör ücreti dahildir. 	50	2"	178
	65	2 1/2"	178
	80	3"	178
	100	4"	178
	125	5"	178
	150	6"	314
	200	8"	314
	250	10"	533
	300	12"	533

01.02.2026

FAF 2500

Y TİP PİSLİK TUTUCU - PN16 - TOZ BOYALI



ÜRÜN ÖZELLİKLERİ	ÇAP		FAF2500
	MM	İNÇ	FİYAT \$
<ul style="list-style-type: none"> GGG50 sfero dökümdür. DN15-DN600 Filtre Delik Standardı: 20 Mesh. Filtre ve dış koruma sacı paslanmaz çeliktir. Gövdeye yerleştirilen kapak çıkartılarak, detaylı temizlik yapılabilir veya filtre değiştirilebilir. Boşaltım tapası piriştir. Toz boyalı max. kullanım sıcaklığı 130°C'dir. Pislik tutucular DN200 ve üzeri için, PN10 flanş normunda üretim yapılabilir. <p>* DSİ şartnamesine uygun olarak üretim yapılabilmektedir.</p>	15	1/2"	41
	20	3/4"	47
	25	1"	54
	32	1 1/4"	79
	40	1 1/2"	91
	50	2"	115
	65	2 1/2"	145
	80	3"	182
	100	4"	226
	125	5"	306
	150	6"	462
	200	8"	911
	250	10"	1514
	300	12"	2237
350	14"	3248	
400	16"	4941	
500	20"	8830	
600	24"	* FİYAT BİLGİSİ ALINIZ	

FAF 2100

GLOB VANA - PN16



ÜRÜN ÖZELLİKLERİ	ÇAP		FAF2100
	MM	İNÇ	FİYAT \$
<ul style="list-style-type: none"> Gövde, kapak ve volan GG25 pik dökümdür. Sızdırmazlık elemanı grafitir. Mili paslanmaz çeliktir. Maksimum kullanım sıcaklığı 200°C'dir. 	15	1/2"	80
	20	3/4"	92
	25	1"	113
	32	1 1/4"	174
	40	1 1/2"	203
	50	2"	293
	65	2 1/2"	390
	80	3"	555
	100	4"	729
	125	5"	1139
	150	6"	1463
	200	8"	2295
250	10"	3957	
300	12"	6554	

01.02.2026

FAF 2130

GLOB VANA - METAL KÖRÜKLÜ - PN16



ÜRÜN ÖZELLİKLERİ	ÇAP		FAF2130
	MM	İNÇ	FİYAT \$
<ul style="list-style-type: none"> Gövde ve kapak pik dökümdür. Volan alüminyum malzemeden imal edilmiştir. Sızdırmazlık elemanı grafitir. Mili paslanmaz çeliktir. Maksimum kullanım sıcaklığı 200°C'dir. 	15	1/2"	172
	20	3/4"	184
	25	1"	218
	32	1 1/4"	269
	40	1 1/2"	304
	50	2"	369
	65	2 1/2"	496
	80	3"	698
	100	4"	916
	125	5"	1380
	150	6"	1793
	200	8"	2953
	250	10"	5120
300	12"	7612	

FAF 2270

ÇEKVALF - ÇALPARA - PN10-16



ÜRÜN ÖZELLİKLERİ	ÇAP		FAF2271 (PN10)	FAF2270 (PN16)
	MM	İNÇ	FİYAT \$	FİYAT \$
<ul style="list-style-type: none"> Gövde, kapak GGG50 sfero dökümdür. Mili paslanmaz çeliktir. Klape çelik olup üzeri vulkanize kauçuk kaplı EPDM'dir. Maksimum kullanım sıcaklığı 120°C'dir. 	50	2"	177	177
	65	2 1/2"	227	227
	80	3"	285	285
	100	4"	319	319
	125	5"	453	453
	150	6"	571	571
	200	8"	943	939
	250	10"	1386	1401
	300	12"	1949	1950

01.02.2026

FAF 2270K

ÇEKVALF - ÇALPARA - KARŞI AĞIRLIK - PN10-16



ÜRÜN ÖZELLİKLERİ	ÇAP		FAF2271K (PN10)	FAF2270K (PN16)
	MM	İNÇ	FİYAT \$	FİYAT \$
<ul style="list-style-type: none"> Gövde, kapak GGG50 sfero dökümdür. Hassas akış kontrollü için ağırlıkların mesafesi ayarlanabilir. Mil yatağı MS-58 pirinçtir. Klape çelik olup üzeri vulkanize kauçuk kaplı EPDM'dir. Dikey montaj uygulamalarında sipariş öncesi bilgi verilmelidir. Maksimum kullanım sıcaklığı 120°C'dir. 	50	2"	369	369
	65	2 1/2"	424	424
	80	3"	516	516
	100	4"	595	595
	125	5"	776	776
	150	6"	938	938
	200	8"	1377	1365
	250	10"	2163	2159
300	12"	2938	2939	

FAF 2250

ÇEKVALF - YAYLI - PN16



ÜRÜN ÖZELLİKLERİ	ÇAP		FAF2250
	MM	İNÇ	FİYAT \$
<ul style="list-style-type: none"> Gövde, kapak GG25 pik dökümdür. Sızdırmazlık elemanı grafitir. Maksimum kullanım sıcaklığı 200°C'dir. 	15	1/2"	75
	20	3/4"	89
	25	1"	107
	32	1 1/4"	157
	40	1 1/2"	188
	50	2"	267
	65	2 1/2"	386
	80	3"	540
	100	4"	740
	125	5"	1066
	150	6"	1403
	200	8"	2261

01.02.2026

FAF 2290

ÇEKVALF - TOPLU - FLANŞLI - PN10-16



ÜRÜN ÖZELLİKLERİ	ÇAP		FAF2290 (PN16)	FAF2291 (PN10)
	MM	İNÇ	FİYAT \$	FİYAT \$
<ul style="list-style-type: none"> Gövde, kapak sfero dökümdür. Top NBR kaplı çeliktir. Atıksu uygulamaları için uygundur. Maksimum kullanım sıcaklığı 70°C'dir. 	50	2"	211	211
	65	2 1/2"	289	289
	80	3"	347	347
	100	4"	492	492
	125	5"	704	704
	150	6"	991	991
	200	8"	1472	1472
	250	10"	2153	2153
	300	12"	2975	2975

FAF 2300

ÇEKVALF - ÇALPARA - WAFER - KOMPLE PASLANMAZ



ÜRÜN ÖZELLİKLERİ	ÇAP		FAF2300
	MM	İNÇ	FİYAT \$
<ul style="list-style-type: none"> PN16 Basınç sınıfındadır. Sızdırmazlık elemanları NBR'dir. Maksimum çalışma sıcaklığı 80°C'dir. Gövde ve klape 304 paslanmaz çeliktir. 	25	1"	74
	32	1 1/4"	77
	40	1 1/2"	78
	50	2"	88
	65	2 1/2"	117
	80	3"	134
	100	4"	206
	125	5"	318
	150	6"	483
	200	8"	940
	250	10"	1744
	300	12"	2230
	350	14"	3054
400	16"	4426	

01.02.2026

FAF 2330

ÇEKVALF - ÇALPARA - WAFER - ÇELİK GÖVDE - PASLANMAZ KLAPE



ÜRÜN ÖZELLİKLERİ	ÇAP		FAF2330
	MM	İNÇ	FİYAT \$
<ul style="list-style-type: none"> PN16 Basınç sınıfındadır. Sızdırmazlık elemanları NBR'dir. Maksimum çalışma sıcaklığı 80°C'dir. Çelik gövdeli ve paslanmaz klapelidir. 	25	1"	42
	32	1 1/4"	44
	40	1 1/2"	47
	50	2"	52
	65	2 1/2"	61
	80	3"	74
	100	4"	99
	125	5"	138
	150	6"	196
	200	8"	318
	250	10"	623
	300	12"	981
	350	14"	1150
	400	16"	1766
	450	18"	2382
	500	20"	2965
600	24"	8069	
700	28"	9690	

FAF 2370

ÇEKVALF - DISKO - PİRİNÇ



ÜRÜN ÖZELLİKLERİ	ÇAP		FAF2370
	MM	İNÇ	FİYAT \$
<ul style="list-style-type: none"> PN16 Basınç sınıfındadır. Gövde pirinçtir. Disk ve yay paslanmaz çeliktir. Maksimum çalışma sıcaklığı 200°C'dir. 	15	1/2"	44
	20	3/4"	49
	25	1"	56
	32	1 1/4"	79
	40	1 1/2"	88
	50	2"	121
	65	2 1/2"	165
	80	3"	208
	100	4"	290

01.02.2026

FAF 2371

ÇEKVALF - DISKO - SFERO



ÜRÜN ÖZELLİKLERİ	ÇAP		FAF2371
	MM	İNÇ	FİYAT \$
<ul style="list-style-type: none"> PN16 Basınç sınıfındadır. DN125-DN250 çaplarında gövde ve klape sfero dökümdür. DN40-DN100 çaplarında gövde sfero döküm, klape paslanmaz çeliktir. Yay paslanmaz çeliktir. Maksimum çalışma sıcaklığı 200°C'dir. 	40	1 1/2"	41
	50	2"	56
	65	2 1/2"	68
	80	3"	81
	100	4"	101
	125	5"	202
	150	6"	303
	200	8"	390
	250	10"	916

FAF 2372

ÇEKVALF - DISKO - PASLANMAZ - 304



ÜRÜN ÖZELLİKLERİ	ÇAP		FAF2372
	MM	İNÇ	FİYAT \$
<ul style="list-style-type: none"> PN40 Basınç sınıfındadır. Gövde, klape ve baskı yayı 304 paslanmaz çeliktir. Maksimum çalışma sıcaklığı 200°C'dir. 	15	1/2"	45
	20	3/4"	54
	25	1"	58
	32	1 1/4"	66
	40	1 1/2"	81
	50	2"	102
	65	2 1/2"	148
	80	3"	215
	100	4"	275

FAF 2373

ÇEKVALF - DISKO - PASLANMAZ - 316



ÜRÜN ÖZELLİKLERİ	ÇAP		FAF2373
	MM	İNÇ	FİYAT \$
<ul style="list-style-type: none"> PN40 Basınç sınıfındadır. Gövde ve klape 316 paslanmaz çeliktir. Maksimum çalışma sıcaklığı 200°C'dir. 	15	1/2"	65
	20	3/4"	70
	25	1"	77
	32	1 1/4"	87
	40	1 1/2"	107
	50	2"	134
	65	2 1/2"	192
	80	3"	281
	100	4"	353

01.02.2026

FAF 2350
ÇEKVALF - DUAL



ÜRÜN ÖZELLİKLERİ	ÇAP		FAF2350 PASLANMAZ KLAPELİ
	MM	İNÇ	FİYAT \$
<ul style="list-style-type: none"> • PN16 Basınç sınıfındadır. • Gövde GG25 pik dökümdür. • Klape paslanmaz çeliktir. • Sızdırmazlık elemanları EPDM'dir. • Maksimum çalışma sıcaklığı 120°C'dir. 	40	1 1/2"	48
	50	2"	58
	65	2 1/2"	74
	80	3"	107
	100	4"	138
	125	5"	195
	150	6"	255
	200	8"	460
	250	10"	771
	300	12"	1165
	350	14"	1741
	400	16"	2198
	450	18"	3035
	500	20"	3535
600	24"	5080	

FAF 2355
ÇEKVALF - DUAL



ÜRÜN ÖZELLİKLERİ	ÇAP		FAF2355 SFERO KLAPELİ
	MM	İNÇ	FİYAT \$
<ul style="list-style-type: none"> • PN16 Basınç sınıfındadır. • Gövde GG25 pik dökümdür. • Klape sfero döküm üzerine nikel kaplamadır. • Sızdırmazlık elemanları EPDM'dir. • Maksimum çalışma sıcaklığı 120°C'dir. 	40	1 1/2"	45
	50	2"	52
	65	2 1/2"	69
	80	3"	98
	100	4"	125
	125	5"	188
	150	6"	234
	200	8"	413
	250	10"	699
	300	12"	1015
	350	14"	1408
	400	16"	2004

01.02.2026

FAF 3500

KELEBEK VANA - WAFER TİP - SS304 PASLANMAZ KLAPELİ



ÜRÜN ÖZELLİKLERİ	ÇAP		FAF3500 EL KUMANDALI FİYAT \$	CONTA FARKI	
	MM	İNÇ		NBR	VITON
<ul style="list-style-type: none"> DN40- DN600 için PN6-10-16 Class 150 Flanş bağlantısına uyumludur. SS304 paslanmaz klapelidir. DN40-DN150 Gövde GG25 pik dökümdür. Siparişe göre sfero gövdeli üretim yapılabilir. DN200 üzeri Gövde GGG50 sfero dökümdür. Liste fiyatları EPDM contalı vana içindir. NBR veya VITON contalı vanalar için, conta fiyat farkı tablosundaki değerler liste fiyatına eklenir. 	40	1 1/2"	60	14	170
	50	2"	70	16	180
	65	2 1/2"	80	16	260
	80	3"	90	18	420
	100	4"	126	28	520
	125	5"	172	58	600
	150	6"	220	64	900
	200	8"	373	82	1280
	250	10"	567	100	1660
	300	12"	797	110	2200

* DSİ şartnamesine uygun olarak üretim yapılabilmektedir.

FAF 3500D

KELEBEK VANA - WAFER TİP - SS304 PASLANMAZ KLAPELİ



ÜRÜN ÖZELLİKLERİ	ÇAP		FAF3500D DİŞLİ KUTULU FİYAT \$
	MM	İNÇ	
<ul style="list-style-type: none"> DN40- DN600 için PN6-10-16 Class 150 Flanş bağlantısına uyumludur. SS304 paslanmaz klapelidir. DN40-DN150 Gövde GG25 pik dökümdür. Siparişe göre sfero gövdeli üretim yapılabilir. DN200 ve üzeri Gövde GGG50 sfero dökümdür. Liste fiyatları EPDM contalı vana içindir. NBR veya VITON contalı vanalar için, conta fiyat farkı tablosundaki değerler liste fiyatına eklenir. Dişli kutusu fiyatlara dahildir. 	40	1 1/2"	130
	50	2"	142
	65	2 1/2"	153
	80	3"	162
	100	4"	198
	125	5"	242
	150	6"	293
	200	8"	499
	250	10"	699
	300	12"	942
	350	14"	1697
	400	16"	2464
	450	18"	3229
500	20"	4042	
600	24"	6808	

01.02.2026

FAF 3550

KELEBEK VANA - WAFER TİP - NİKEL KAPLI - SFERO KLAPELİ



ÜRÜN ÖZELLİKLERİ	ÇAP		FAF3550 EL KUMANDALI	CONTA FARKI	
	MM	İNÇ	FİYAT \$	NBR	VITON
<ul style="list-style-type: none"> DN40- DN600 için PN6-10-16 Class 150 Flanş bağlantısına uyumludur. Nikel kaplı, sfere döküm klapelidir. DN40-DN150 Gövde GG25 pik dökümdür. Siparişe göre sfere gövdeli üretim yapılabilir. DN200 ve üzeri Gövde GGG50 sfere dökümdür. Liste fiyatları EPDM contalı vana içindir. NBR veya VITON contalı vanalar için, conta fiyat farkı tablosundaki değerler liste fiyatına eklenir. 	40	1 1/2"	58	14	170
	50	2"	69	16	180
	65	2 1/2"	75	16	260
	80	3"	87	18	420
	100	4"	107	28	520
	125	5"	139	58	600
	150	6"	170	64	900
	200	8"	297	82	1280
	250	10"	431	100	1660
	300	12"	533	110	2200

FAF 3550D

KELEBEK VANA - WAFER TİP - NİKEL KAPLI - SFERO KLAPELİ



ÜRÜN ÖZELLİKLERİ	ÇAP		FAF3550D DIŞLI KUTULU
	MM	İNÇ	FİYAT \$
<ul style="list-style-type: none"> DN40- DN600 için PN6-10-16 Class 150 Flanş bağlantısına uyumludur. DN40-DN300 nikel kaplı, sfere döküm klapelidir. DN350-DN600 çaplar klape üzeri boya ile kaplıdır. DN40-DN150 Gövde GG25 pik dökümdür. Siparişe göre sfere gövdeli üretim yapılabilir. DN200 ve üzeri Gövde GGG50 sfere dökümdür. Liste fiyatları EPDM contalı vana içindir. NBR veya VITON contalı vanalar için, conta fiyat farkı tablosundaki değerler liste fiyatına eklenir. Dişli kutusu fiyatlara dahildir. 	40	1 1/2"	128
	50	2"	141
	65	2 1/2"	148
	80	3"	161
	100	4"	176
	125	5"	212
	150	6"	242
	200	8"	423
	250	10"	561
	300	12"	682
	350	14"	1397
	400	16"	2031
	450	18"	2683
500	20"	3317	
600	24"	5419	

01.02.2026

FAF 3560

KELEBEK VANA - WAFER TİP - SS316 PASLANMAZ KLAPELİ



ÜRÜN ÖZELLİKLERİ	ÇAP		FAF3560 EL KUMANDALI	CONTA FARKI	
	MM	İNÇ		FİYAT \$	NBR
<ul style="list-style-type: none"> DN40- DN600 için PN6-10-16 Class 150 Flanş bağlantısına uyumludur. SS316 paslanmaz klapelidir. DN40-DN150 Gövde GG25 pik dökümdür. Siparişe göre sfero gövdeli üretim yapılabilir. DN200 ve üzeri Gövde GGG50 sfero dökümdür. Liste fiyatları EPDM contalı vana içindir. NBR veya VITON contalı vanalar için, conta fiyat farkı tablosundaki değerler liste fiyatına eklenir. 	40	1 1/2"	68	14	170
	50	2"	77	16	180
	65	2 1/2"	91	16	260
	80	3"	101	18	420
	100	4"	151	28	520
	125	5"	211	58	600
	150	6"	270	64	900
	200	8"	397	82	1280
	250	10"	599	100	1660
	300	12"	983	110	2200

FAF 3560D

KELEBEK VANA - WAFER TİP - SS316 PASLANMAZ KLAPELİ



ÜRÜN ÖZELLİKLERİ	ÇAP		FAF3560D DIŞLI KUTULU
	MM	İNÇ	
<ul style="list-style-type: none"> DN40- DN600 için PN6-10-16 Class 150 Flanş bağlantısına uyumludur. SS316 paslanmaz klapelidir. DN40-DN150 Gövde GG25 pik dökümdür. Siparişe göre sfero gövdeli üretim yapılabilir. DN200 ve üzeri Gövde GGG50 sfero dökümdür. Liste fiyatları EPDM contalı vana içindir. NBR veya VITON contalı vanalar için, conta fiyat farkı tablosundaki değerler liste fiyatına eklenir. 	40	1 1/2"	139
	50	2"	150
	65	2 1/2"	161
	80	3"	174
	100	4"	221
	125	5"	281
	150	6"	341
	200	8"	540
	250	10"	775
	300	12"	1133
	350	14"	2104
	400	16"	3094
450	18"	3843	
500	20"	4960	
600	24"	7632	

01.02.2026

FAF 3600

KELEBEK VANA - LUG TİP - SS304 PASLANMAZ KLAPELİ



ÜRÜN ÖZELLİKLERİ	ÇAP		FAF3600 EL KUMANDALI	CONTA FARKI	
	MM	İNÇ	FİYAT \$	NBR	VITON
<ul style="list-style-type: none"> DN40 - DN600 için PN16 Flanş bağlantısına uyumludur. SS304 paslanmaz klapelidir. DN40-DN150 Gövde GG25 pik dökümdür. Siparişe göre sfero gövdeli üretim yapılabilir. DN200 ve üzeri Gövde GGG50 sfero dökümdür. Liste fiyatları EPDM contalı vana içindir. NBR veya VITON contalı vanalar için, conta fiyat farkı tablosundaki değerler liste fiyatına eklenir. <p>* DSI şartnamesine uygun olarak üretim yapılabilmektedir.</p>	40	1 1/2"	72	14	170
	50	2"	80	16	180
	65	2 1/2"	97	16	260
	80	3"	118	18	420
	100	4"	158	28	520
	125	5"	211	58	600
	150	6"	258	64	900
	200	8"	459	82	1280
	250	10"	672	100	1660
	300	12"	951	110	2200

FAF 3600D

KELEBEK VANA - LUG TİP - SS304 PASLANMAZ KLAPELİ



ÜRÜN ÖZELLİKLERİ	ÇAP		FAF3600D DIŞLI KUTULU
	MM	İNÇ	FİYAT \$
<ul style="list-style-type: none"> DN40 - DN600 için PN16 Flanş bağlantısına uyumludur. SS304 paslanmaz klapelidir. DN40-DN150 Gövde GG25 pik dökümdür. Siparişe göre sfero gövdeli üretim yapılabilir. DN200 ve üzeri Gövde GGG50 sfero dökümdür. Liste fiyatları EPDM contalı vana içindir. NBR veya VITON contalı vanalar için, conta fiyat farkı tablosundaki değerler liste fiyatına eklenir. 	40	1 1/2"	142
	50	2"	150
	65	2 1/2"	167
	80	3"	188
	100	4"	229
	125	5"	282
	150	6"	331
	200	8"	583
	250	10"	802
	300	12"	1103
	350	14"	2124
	400	16"	3101
	450	18"	4092
	500	20"	5354
600	24"	8086	

01.02.2026

FAF 3650

KELEBEK VANA - LUG TİP - NİKEL KAPLI - SFERO KLAPELİ



ÜRÜN ÖZELLİKLERİ	ÇAP		FAF3650 EL KUMANDALI	CONTA FARKI	
	MM	İNÇ	FİYAT \$	NBR	VITON
<ul style="list-style-type: none"> DN40 - DN600 için PN16 Flanş bağlantısına uyumludur. Nikel kaplı, sfero döküm klapelidir. DN40-DN150 Gövde GG25 pik dökümdür. Siparişe göre sfero gövdeli üretim yapılabilir. DN200 ve üzeri Gövde GGG50 sfero dökümdür. Liste fiyatları EPDM contalı vana içindir. NBR veya VITON contalı vanalar için, conta fiyat farkı tablosundaki değerler liste fiyatına eklenir. 	40	1 1/2"	70	14	170
	50	2"	79	16	180
	65	2 1/2"	90	16	260
	80	3"	108	18	420
	100	4"	131	28	520
	125	5"	167	58	600
	150	6"	196	64	900
	200	8"	380	82	1280
	250	10"	528	100	1660
	300	12"	673	110	2200

FAF 3650D

KELEBEK VANA - LUG TİP - NİKEL KAPLI - SFERO KLAPELİ



ÜRÜN ÖZELLİKLERİ	ÇAP		FAF3650D DIŞLI KUTULU
	MM	İNÇ	FİYAT \$
<ul style="list-style-type: none"> DN40 - DN600 için PN16 Flanş bağlantısına uyumludur. DN40-DN300 nikel kaplı, sfero döküm klapelidir. DN350-DN600 çaplar klape üzeri boya ile kaplıdır. DN40-DN150 Gövde GG25 pik dökümdür. Siparişe göre sfero gövdeli üretim yapılabilir. DN200 ve üzeri Gövde GGG50 sfero dökümdür. Liste fiyatları EPDM contalı vana içindir. NBR veya VITON contalı vanalar için, conta fiyat farkı tablosundaki değerler liste fiyatına eklenir. 	40	1 1/2"	140
	50	2"	150
	65	2 1/2"	162
	80	3"	181
	100	4"	198
	125	5"	237
	150	6"	269
	200	8"	506
	250	10"	654
	300	12"	823
	350	14"	1682
	400	16"	2461
	450	18"	3274
500	20"	4243	
600	24"	6267	

01.02.2026

FAF 3660

KELEBEK VANA - LUG TİP - SS316 PASLANMAZ KLAPELİ



ÜRÜN ÖZELLİKLERİ	ÇAP		FAF3660 EL KUMANDALI FİYAT \$	CONTA FARKI	
	MM	İNÇ		NBR	VITON
<ul style="list-style-type: none"> DN40 - DN600 için PN16 Flanş bağlantısına uyumludur. SS316 paslanmaz klapelidir. DN40-DN150 Gövde GG25 pik dökümdür. Siparişe göre sfero gövdeli üretim yapılabilir. DN200 ve üzeri Gövde GGG50 sfero dökümdür. Liste fiyatları EPDM contalı vana içindir. NBR veya VITON contalı vanalar için, conta fiyat farkı tablosundaki değerler liste fiyatına eklenir. 	40	1 1/2"	81	14	170
	50	2"	88	16	180
	65	2 1/2"	104	16	260
	80	3"	127	18	420
	100	4"	170	28	520
	125	5"	232	58	600
	150	6"	298	64	900
	200	8"	479	82	1280
	250	10"	705	100	1660
	300	12"	1018	110	2200

FAF 3660D

KELEBEK VANA - LUG TİP - SS316 PASLANMAZ KLAPELİ



ÜRÜN ÖZELLİKLERİ	ÇAP		FAF3660D DIŞLI KUTULU FİYAT \$
	MM	İNÇ	
<ul style="list-style-type: none"> DN40 - DN600 için PN16 Flanş bağlantısına uyumludur. SS316 paslanmaz klapelidir. DN40-DN150 Gövde GG25 pik dökümdür. Siparişe göre sfero gövdeli üretim yapılabilir. DN200 ve üzeri Gövde GGG50 sfero dökümdür. Liste fiyatları EPDM contalı vana içindir. NBR veya VITON contalı vanalar için, conta fiyat farkı tablosundaki değerler liste fiyatına eklenir. 	40	1 1/2"	151
	50	2"	158
	65	2 1/2"	174
	80	3"	197
	100	4"	241
	125	5"	303
	150	6"	371
	200	8"	605
	250	10"	831
	300	12"	1168
	350	14"	2594
	400	16"	3557
	450	18"	4697
500	20"	6183	
600	24"	9393	

01.02.2026

FAF 3751

TEK ETKİLİ PNÖMATİK AKTUATÖRLÜ KELEBEK VANA

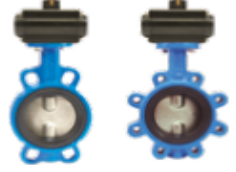

ÜRÜN ÖZELLİKLERİ	TEK ETKİLİ		FAF3500P	FAF3550P	FAF3600P	FAF3650P
	DN	TORK _(NM)	FİYAT \$	FİYAT \$	FİYAT \$	FİYAT \$
<ul style="list-style-type: none"> Tork değerleri 6 bar kaynak basıncına göre belirlenmiştir. Aktuatör seçimi aktuatör tipi, moment gereksinimi ve bağlantı ölçüleri esas alınarak yapılmalıdır. Farklı kaynak basınçlarında kullanım için bize ulaşınız. Aşağıdaki aksesuarlarla beraber tedarik edilebilir: <ul style="list-style-type: none"> Yön Valfi Oransal çalışma için pozisyoner Plastik kutulu switch Alüminyum kutulu switch Ex-proof switch kutusu Proximity switchli switch kutusu Tork değerleri ve fiyatlar paslanmaz klapeli kelebek vana seçimleri içindir. 	40	15	* FİYAT BİLGİSİ ALINIZ			
	50	15				
	65	15				
	80	23				
	100	54				
	125	70				
	150	100				
	200	171				
	250	240				
	300	380				

FAF 3750

ÇİFT ETKİLİ PNÖMATİK AKTUATÖRLÜ KELEBEK VANA

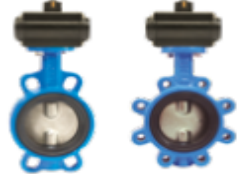

ÜRÜN ÖZELLİKLERİ	ÇİFT ETKİLİ		FAF3500P	FAF3550P	FAF3600P	FAF3650P
	DN	TORK _(NM)	FİYAT \$	FİYAT \$	FİYAT \$	FİYAT \$
<ul style="list-style-type: none"> Tork değerleri 6 bar kaynak basıncına göre belirlenmiştir. Aktuatör seçimi aktuatör tipi, moment gereksinimi ve bağlantı ölçüleri esas alınarak yapılmalıdır. Farklı kaynak basınçlarında kullanım için bize ulaşınız. Aşağıdaki aksesuarlarla beraber tedarik edilebilir: <ul style="list-style-type: none"> Yön Valfi Oransal çalışma için pozisyoner Plastik kutulu switch Alüminyum kutulu switch Ex-proof switch kutusu Proximity switchli switch kutusu Tork değerleri ve fiyatlar paslanmaz klapeli kelebek vana seçimleri içindir. 	40	15	* FİYAT BİLGİSİ ALINIZ			
	50	15				
	65	15				
	80	23				
	100	54				
	125	70				
	150	100				
	200	171				
	250	240				
	300	380				

01.02.2026

FAF 3770

ELEKTRİK AKTUATÖRLÜ KELEBEK VANA - ÇEYREK TURLU

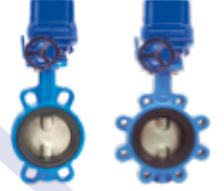

ÜRÜN ÖZELLİKLERİ	ELEKTRİK AKTUATÖR		FAF3500E	FAF3550E	FAF3600E	FAF3650E
	DN	TORK _(NM)	FİYAT \$	FİYAT \$	FİYAT \$	FİYAT \$
<ul style="list-style-type: none"> Aktuatör bağlantı ölçüleri ISO5211 standartına göre belirlenmiştir. Aktuatör seçimi aktuatör tipi, moment gereksinimi ve bağlantı ölçüleri esas alınarak yapılmalıdır. 220 Volt. Ürün ON-OFF kontrollü tipidir. Oransal kontrol için opsiyonlu fiyat verilebilir. Oransal kontrol 4-20mA veya 0-10 VDC kontrol sinyali ile sağlanabilir. Opsiyonel olarak Ex-Proof, uzaktan kontrol ünitesi, LCD göstergeli olarak tedarik edilebilir. Tork değerleri ve fiyatlar paslanmaz klapeli kelebek vana seçimleri içindir. 	40	15	* FİYAT BİLGİSİ ALINIZ			
	50	15				
	65	15				
	80	23				
	100	54				
	125	70				
	150	100				
	200	171				
250	240					
300	380					

FAF 3780

ELEKTRİKLİ AKTUATÖR - ÇOK TURLU



ÜRÜN ÖZELLİKLERİ	TORK (NM)	FAF3780
		FİYAT \$
<ul style="list-style-type: none"> Aktuatör bağlantı ölçüleri ISO5211 standardına göre belirlenmiştir. Aktuatör seçimi aktuatör tipi, moment gereksinimi, kumanda mili tur sayısı ve bağlantı ölçüleri esas alınarak yapılmalıdır. 380V/220V/110VAC veya 110/24VDC güç kaynağına göre üretilir. ON-OFF ve Oransal kontrollü olmak üzere ikiye ayrılır. Oransal kontrol 4-20mA veya 0-10 VDC kontrol sinyali ile sağlanabilir. 	30	* FİYAT BİLGİSİ ALINIZ
	60	
	120	
	250	
	500	
	1000	

01.02.2026

FAF 3800

FLANŞLI KELEBEK VANA ÇİFT EKSANTRİK

WRAS



ÜRÜN ÖZELLİKLERİ	ÇAP		FAF3810 (PN10)	FAF3810P (PN10)	FAF3800 (PN16)	FAF3800P (PN16)
	MM	İNÇ	FİYAT \$	FİYAT \$	FİYAT \$	FİYAT \$
<ul style="list-style-type: none"> • Şartnameye göre özel üretimler yapılmaktadır. • Çift eksantrik konumlanmış klapelidir. • Gövde ve klape GGG50 sfero dökümdür. • DN2000'e kadar üretim yapılmaktadır. • Vananın iç ve dış yüzeyleri 250 mikron termoplastik boya ile kaplanır. • Farklı boya kalınlıkları yapılabilir. • Baskı çemberi St 37 çelik olarak standart üretimdir. Paslanmaz çemberli üretim isteğe bağlı olarak yapılabilir. • PN25 üretim yapılmaktadır. • 3810P, 3800P kodları paslanmaz çemberlidir. • 3810, 3800 kodları St-37 çelik çemberlidir. • Elektrik Aktüatörü ayrıca temin edilir. • Maksimum sıcaklık 50°C'dir. 	100	4"				
	125	5"				
	150	6"				
	200	8"				
	250	10"				
	300	12"				
	350	14"				
	400	16"				
	450	18"				
	500	20"				
	600	24"				
	700	28"				
	800	32"				
	900	36"				
	1000	40"				
1200	48"					
1400	56"					
1600	62"					
1800	72"					

* FİYAT BİLGİSİ ALINIZ

* Teklif talebi aşamasında fiyatlandırılacaktır.

FAF 3800E

FLANŞLI KELEBEK VANA ÇİFT EKSANTRİK - AKTUATÖR UYUMLU



WRAS



ÜRÜN ÖZELLİKLERİ	ÇAP		FAF3810E (PN10)	FAF3810EP (PN10)	FAF3800E (PN16)	FAF3800EP (PN16)
	MM	İNÇ	FİYAT \$	FİYAT \$	FİYAT \$	FİYAT \$
<ul style="list-style-type: none"> • Şartnameye göre özel üretimler yapılmaktadır. • Çift eksantrik konumlanmış klapelidir. • Gövde ve klape GGG50 sfero dökümdür. • DN2000'e kadar üretim yapılmaktadır. • Vananın iç ve dış yüzeyleri 250 mikron termoplastik boya ile kaplanır. • Farklı boya kalınlıkları yapılabilir. • Baskı çemberi St 37 çelik olarak standart üretimdir. Paslanmaz çemberli üretim isteğe bağlı olarak yapılabilir. • PN25 üretim yapılmaktadır. • 3810EP, 3800EP kodları paslanmaz çemberlidir. • 3810, 3800 kodları St-37 çelik çemberlidir. • Elektrik Aktüatörü ayrıca temin edilir. • Maksimum sıcaklık 50°C'dir. * DSI şartnamesine uygun olarak üretim yapılabilmektedir. 	100	4"				
	125	5"				
	150	6"				
	200	8"				
	250	10"				
	300	12"				
	350	14"				
	400	16"				
	450	18"				
	500	20"				
	600	24"				
	700	28"				
	800	32"				
	900	36"				
	1000	40"				
1200	48"					
1400	56"					
1600	62"					
1800	72"					

* FİYAT BİLGİSİ ALINIZ

01.02.2026

FAF 6000

SÜRGÜLÜ VANA - F4 - SFERO



ÜRÜN ÖZELLİKLERİ	ÇAP		FAF6010 (PN10)	FAF6000 (PN16)	FAF6025 (PN25)
	MM	İNÇ	FİYAT \$	FİYAT \$	FİYAT \$
<ul style="list-style-type: none"> Elastomer baskılı sürgü ile %100 sızdırmazlık sağlar. Gövde ve kapak sfero dökümdür. Sızdırmazlık elemanları ve sürgü EPDM'dir F4 montaj boyundadır. FAF 6010 PN 10 Flanş ölçülerine sahiptir. Maksimum sıcaklık 50°C'dir. <p>* DSI şartnamesine uygun olarak üretim yapılabilmektedir.</p>	40	1 1/2"	138	138	196
	50	2"	149	149	228
	65	2 1/2"	183	183	267
	80	3"	210	210	315
	100	4"	258	258	400
	125	5"	332	332	521
	150	6"	413	413	917
	200	8"	715	715	1330
	250	10"	1240	1240	1860
	300	12"	1672	1672	2240
	350	14"	2568	2568	-
	400	16"	3279	3279	-
	450	18"	4804	4804	-
	500	20"	6435	6435	-
600	24"	8985	8985	-	

FAF 6200

SÜRGÜLÜ VANA - F5 - SFERO



ÜRÜN ÖZELLİKLERİ	ÇAP		FAF6210 (PN10)	FAF6200 (PN16)	FAF6225 (PN25)
	MM	İNÇ	FİYAT \$	FİYAT \$	FİYAT \$
<ul style="list-style-type: none"> Elastomer baskılı sürgü ile %100 sızdırmazlık sağlar. Gövde ve kapak sfero dökümdür. Sızdırmazlık elemanları ve sürgü EPDM'dir F5 montaj boyundadır. FAF 6210 PN 10 Flanş ölçülerine sahiptir. Maksimum sıcaklık 50°C'dir. 	50	2"	185	185	249
	65	2 1/2"	245	232	348
	80	3"	270	270	363
	100	4"	342	342	478
	125	5"	513	513	734
	150	6"	539	539	748
	200	8"			
	250	10"			
	300	12"			
	350	14"			
	400	16"			
	450	18"			
	500	20"			
	600	24"			

* FİYAT BİLGİSİ ALINIZ

01.02.2026

FAF 6500

BIÇAKLI YÜKSELEN MİLLİ VANA - PN10



ÜRÜN ÖZELLİKLERİ	ÇAP		FAF6500 (PN10)
	MM	İNÇ	FİYAT \$
<ul style="list-style-type: none"> • PN10 Basınç sınıfındadır. • Gövde, sfero döküm. • Bıçak AISI 304 paslanmaz çeliktir. • Sızdırmazlık elemanı NBR'dir. • Maksimum çalışma sıcaklığı 50°C'dir. • Çalışma basıncı çap yükseldikçe azalmaktadır. • Flanş normu PN10'dur. • Basınç tek taraflı uygulanır. • DN500 ve DN600'lük çaplarda çift yönlü sızdırmazlık sağlar. • SS 304 klapelidir. <p>* SS 316 klape için fiyat sorunuz. * DSI şartnamesine uygun olarak üretim yapılabilmektedir.</p>	80	3"	* FİYAT BİLGİSİ ALINIZ
	100	4"	
	125	5"	
	150	6"	
	200	8"	
	250	10"	
	300	12"	
	350	14"	
	400	16"	
	500	20"	
600	24"		

FAF 6600

SÜRGÜLÜ VANALAR - DIŞLI



ÜRÜN ÖZELLİKLERİ	ÇAP		FAF6600 (PN16)
	MM	İNÇ	FİYAT \$
<ul style="list-style-type: none"> • Elastomer baskılı sürgü ile %100 sızdırmazlık sağlar. • Gövde ve kapak sfero dökümdür. • Sızdırmazlık elemanları ve sürgü EPDM'dir. • Fiyatlara volan dahil değildir. 	20	3/4"	55
	25	1"	57
	32	1 1/4"	63
	40	1 1/2"	81
	50	2"	84

FAF 6700

METAL YATAKLI SÜRGÜLÜ VANA - YÜKSELEN MİLLİ



ÜRÜN ÖZELLİKLERİ	ÇAP		FAF6700 (PN16)
	MM	İNÇ	FİYAT \$
<ul style="list-style-type: none"> • Gövde ve disk GGG50 sfero dökümdür. • Sit yüzeyi MS58 pirinçtir. • F4 Montaj boyundadır. • PN16 basınç sınıfındadır. 	50	2"	225
	65	2 1/2"	262
	80	3"	362
	100	4"	468
	125	5"	669
	150	6"	823
	200	8"	1322
	250	10"	2019
	300	12"	2737

01.02.2026

FAF 6550

BIÇAKLI YÜKSELMİYEN MİLLİ VANA - PN10



ÜRÜN ÖZELLİKLERİ	ÇAP		FAF6550 (PN10)
	MM	İNÇ	FİYAT \$
<ul style="list-style-type: none"> PN10 Basınç sınıfındadır. Gövde, sfere dökümdür. Biçak AISI 304 paslanmaz çeliktir. Sızdırmazlık elemanı NBR'dir. Maksimum çalışma sıcaklığı 50°C'dir. Çalışma basıncı çap yükseldikçe azalmaktadır. Flanş normu PN10'dur. Basınç tek taraflı uygulanır. DN500 ve DN600'lük çaplarda çift yönlü sızdırmazlık sağlar. SS 304 klapelidir. <p>* SS 316 klape için fiyat sorunuz.</p>	80	3"	269
	100	4"	294
	125	5"	375
	150	6"	414
	200	8"	625
	250	10"	847
	300	12"	1100
	350	14"	1447
	400	16"	1967
	500	20"	4019
600	24"	4618	

FAF 6500P

BIÇAKLI PNÖMATİK PİSTONLU VANA - PN10



ÜRÜN ÖZELLİKLERİ	ÇAP		FAF6500P
	MM	İNÇ	FİYAT \$
<ul style="list-style-type: none"> PN10 Basınç sınıfındadır. Gövde sfere dökümdür. Biçak AISI 304 paslanmaz çeliktir. Sızdırmazlık elemanı NBR'dir. Maksimum çalışma sıcaklığı 50°C'dir. Çalışma basıncı çap yükseldikçe azalmaktadır. Pnömatik piston vasıtasıyla açma-kapama yapılır. Limit switch için ilave fiyat farkı alınır. Basınç tek taraflı uygulanır. SS 304 klapelidir. <p>* SS 316 klape için fiyat sorunuz.</p>	80	3"	* FİYAT BİLGİSİ ALINIZ
	100	4"	
	125	5"	
	150	6"	
	200	8"	
	250	10"	
	300	12"	
	400	16"	
	500	20"	
	600	24"	

01.02.2026

FAF 7100

YERÜSTÜ HİDRANT

ÜRÜN ÖZELLİKLERİ	YER ÜSTÜ YANGIN HİDRANTI		FAF7100
			FİYAT \$
<ul style="list-style-type: none"> Fiyatlara hidrant anahtar dahil, ökçe hariçtir. Bağlantı PN16 basınç sınıfındadır. Gövde sfero dökümdür. 	7108145	DN 80 Boy= 1,45 m	803
	7108175	DN 80 Boy= 1,75 m	881
	7108215	DN 80 Boy= 2,15 m	988
	7110145	DN 100 Boy= 1,45 m	870
	7110175	DN 100 Boy= 1,75 m	916
	7110215	DN 100 Boy= 2,15 m	1078

FAF 7100

HİDRANT ÖKÇESİ VE HİDRANT ANAHTARI

ÜRÜN ÖZELLİKLERİ	MODEL	FAF7100
		FİYAT \$
<ul style="list-style-type: none"> Hidrant'dan ayrı satılır, montajda birlikte kullanılmalıdır Sfero dökümdür. 	DN 80 HİDRANT ÖKÇESİ	97
	DN 100 HİDRANT ÖKÇESİ	114
	HİDRANT ANAHTARI	32

**FAF 7150**

YERALTI HİDRANT - KAZANI

ÜRÜN ÖZELLİKLERİ	MODEL	FAF7150
		FİYAT \$
<ul style="list-style-type: none"> Bağlantı PN16 basınç sınıfındadır. Gövde sfero dökümdür. Hidrant anahtar ve ökçe fiyatlara dahil değildir. 	DN 80 YERALTI YANGIN HİDRANTI	647
	DN 100 YERALTI YANGIN HİDRANTI	719
	YER ALTI YANGIN HİDRANTI KAZANI	370



01.02.2026

FAF 5000

KOMPANSATÖR - KAUCUK, ÇELİK FLANŞLI



ÜRÜN ÖZELLİKLERİ	ÇAP		FAF5000
	MM	İNÇ	FİYAT \$
<ul style="list-style-type: none"> • PN16 flanş normundadır. • Naylon kort karkaslı EPDM kauçuk kullanılmaktadır. • Çelik flanşlı olarak üretilmektedir. • Maksimum basınç 10 bar'dır. 	32	1 1/4"	35
	40	1 1/2"	36
	50	2"	40
	65	2 1/2"	59
	80	3"	71
	100	4"	84
	125	5"	122
	150	6"	160
	200	8"	239
	250	10"	377
	300	12"	465
	350	14"	660
	400	16"	799
	450	18"	1150
	500	20"	1280
600	24"	1950	

FAF 5060

KOMPANSATÖR - KAUCUK, SFERO FLANŞLI



ÜRÜN ÖZELLİKLERİ	ÇAP		FAF5060	FAF5061
	MM	İNÇ	EPDM KAUCUK	NBR KAUCUK
<ul style="list-style-type: none"> • PN16 flanş normundadır. • Naylon kort karkaslı EPDM ve NBR kauçuk kullanılmaktadır. • Sfero döküm flanşlı olarak üretilmektedir. • Maksimum basınç 10 bar'dır. 			FİYAT \$	FİYAT \$
	25	1"	40	55
	32	1 1/4"	42	57
	40	1 1/2"	47	64
	50	2"	54	73
	65	2 1/2"	67	92
	80	3"	81	110
	100	4"	102	138
	125	5"	128	174
	150	6"	161	219
	200	8"	216	294
	250	10"	304	413
	300	12"	472	641

01.02.2026

FAF 5070

KOMPANSATÖR - KAUCUK, DIŞLI



ÜRÜN ÖZELLİKLERİ	ÇAP		FAF5070
	MM	İNÇ	FİYAT \$
<ul style="list-style-type: none"> Naylon kort karkaslı EPDM kauçuk kullanılmaktadır. Maksimum çalışma basıncı 10 bar'dır. 	15	1/2"	20
	20	3/4"	23
	25	1"	25
	32	1 1/4"	29
	40	1 1/2"	35
	50	2"	44
	65	2 1/2"	64

FAF 5500

KOMPANSATÖR - TİTREŞİM YUTUCU



ÜRÜN ÖZELLİKLERİ	ÇAP		FAF5500
	MM	İNÇ	FİYAT \$
<ul style="list-style-type: none"> PN16 Basınç Sınıfındadır. 5500 modeli flanş bağlantılıdır. Flanş St37 çelik, Körük çift katlı AISI304 paslanmaz çeliktir. -20°C → 430°C sıcaklık aralığında kullanılabilir. Pompa giriş ve çıkış hatlarında kullanım için uygundur. 	25	1"	115
	32	1 1/4"	119
	40	1 1/2"	129
	50	2"	141
	65	2 1/2"	166
	80	3"	191
	100	4"	226
	125	5"	277
	150	6"	348
	200	8"	442
	250	10"	726

01.02.2026

FAF 5200

KOMPANSATÖR - DIŞTAN BASINÇLI



ÜRÜN ÖZELLİKLERİ	DÖNER FLANŞLI						KAYNAK BOYUNLU			
	ÇAP		FAF5211 L=30MM	FAF5212 L=60MM	FAF5213 L=90MM	FAF5214 L=120MM	FAF5221 L=30MM	FAF5222 L=60MM	FAF5223 L=90MM	FAF5224 L=120MM
	MM	İNÇ	FİYAT \$	FİYAT \$	FİYAT \$	FİYAT \$	FİYAT \$	FİYAT \$	FİYAT \$	FİYAT \$
<ul style="list-style-type: none"> PN16 Basınç Sınıfındadır. Flanşlı (FAF5210) Kaynak Boyunlu (FAF5220) olarak üretilebilir. Gövde St37 çelik, Körük AISI304 paslanmaz çeliktir. -20°C → 430°C sıcaklık aralığında kullanılabilir. 	25	1"	157	171	187	209	95	114	138	157
	32	1 1/4"	176	186	204	223	105	125	149	166
	40	1 1/2"	183	202	226	232	114	135	152	184
	50	2"	223	241	262	285	133	163	175	210
	65	2 1/2"	258	305	332	354	154	176	204	234
	80	3"	301	366	395	423	191	219	248	286
	100	4"	371	513	543	585	236	290	328	374
	125	5"	533	647	704	771	344	433	472	566
	150	6"	651	761	857	928	467	557	600	714
	200	8"	936	1083	1209	1343	714	857	924	1071
250	10"	1429	1619	1722	1844	873	1081	1238	1360	

FAF 5300

KOMPANSATÖR - DEPREM - KARDAN MAFSALLI



ÜRÜN ÖZELLİKLERİ	FLANŞLI						KAYNAK BOYUNLU			
	ÇAP		FAF5311 100-50MM	FAF5312 100-100MM	FAF5313 100-150MM	FAF5314 100-200MM	FAF5321 100-50MM	FAF5322 100-100MM	FAF5323 100-150MM	FAF5324 100-200MM
	MM	İNÇ	FİYAT \$	FİYAT \$	FİYAT \$	FİYAT \$	FİYAT \$	FİYAT \$	FİYAT \$	FİYAT \$
<ul style="list-style-type: none"> PN16 Basınç Sınıfındadır. Döner Flanşlı (FAF5310) Kaynak Uçlu (FAF5320) Flanşlar St37 çelik, Körük AISI304 paslanmaz çeliktir. -20°C → 430°C sıcaklık aralığında kullanılabilir. 	25	1"	261	271	281	290	209	228	243	252
	32	1 1/4"	269	281	290	300	219	238	252	262
	40	1 1/2"	295	300	314	328	233	255	274	293
	50	2"	390	410	429	448	286	309	333	357
	65	2 1/2"	414	432	449	466	305	352	381	410
	80	3"	502	538	560	586	376	405	434	462
	100	4"	667	686	720	769	491	533	576	619
	125	5"	814	843	895	961	629	671	729	786
	150	6"	1038	1124	1196	1295	835	914	990	1081
	200	8"	1700	1791	1981	2096	1429	1557	1685	1810
250	10"	2267	2361	2605	2763	1779	2000	2191	2381	

01.02.2026

FAF 4000

PİRİNÇ KÜRESEL VANA



ÜRÜN ÖZELLİKLERİ	ÇAP		FAF4000
	MM	İNÇ	FİYAT \$
<ul style="list-style-type: none"> PN25 Basınç Sınıfındadır. TS 13547'ye uygundur. Gövde ve kapak nikel kaplıdır Küre krom kaplı pirinçtir. Küre sızdırmazlık elemanı (PTFE) teflondur. Maksimum çalışma sıcaklığı 90°C'dir. DN65-80-100 çaplar PN16 basınç sınıfındadır. 	15	1/2"	10
	20	3/4"	13
	25	1"	23
	32	1 1/4"	33
	40	1 1/2"	49
	50	2"	77
	65	2 1/2"	174
	80	3"	234
	100	4"	443

FAF 4005

İZOLASYON BOYUNLU PİRİNÇ KÜRESEL VANA



ÜRÜN ÖZELLİKLERİ	ÇAP		FAF4005
	MM	İNÇ	FİYAT \$
<ul style="list-style-type: none"> PN25 Basınç Sınıfındadır. TS 13547'ye uygundur. Gövde ve kapak nikel kaplıdır Küre krom kaplı pirinçtir. Küre sızdırmazlık elemanı (PTFE) teflondur. Maksimum çalışma sıcaklığı 90°C'dir. 	15	1/2"	11
	20	3/4"	13
	25	1"	24
	32	1 1/4"	30
	40	1 1/2"	47
	50	2"	69

01.02.2026

FAF 4060

KÜRESEL KOSVA VANA

YENİ
ÜRÜN

ÜRÜN ÖZELLİKLERİ	ÇAP		FAF4060
	MM	İNÇ	FİYAT \$
<ul style="list-style-type: none"> PN16 basınç sınıfındadır. Gövde ve küre pirinçtir. Küre sızdırmazlık elemanı (PTFE) teflondur. Maksimum çalışma sıcaklığı 90°C'dir. Isıtma tesisatındaki kolon altlarında kullanılır. 	15	1/2"	24
	20	3/4"	32
	25	1"	44
	32	1 1/4"	54
	40	1 1/2"	80
	50	2"	119

FAF 4100

PİRİNÇ KÜRESEL VANA - DOĞALGAZ

GAZMER
ONAYLI

ÜRÜN ÖZELLİKLERİ	ÇAP		FAF4100
	MM	İNÇ	FİYAT \$
<ul style="list-style-type: none"> MOP 0,5 tam geçişlidir. TS EN 331'e uygundur. Gövde ve kapak nikel kaplıdır. Küre krom kaplı pirinçtir. Küre sızdırmazlık elemanı (PTFE) teflondur. Maksimum çalışma sıcaklığı 60°C'dir. 	15	1/2"	12
	20	3/4"	18
	25	1"	29
	32	1 1/4"	43
	40	1 1/2"	66
	50	2"	111

FAF 4010

PİRİNÇ KÜRESEL VANA (E/D)



ÜRÜN ÖZELLİKLERİ	ÇAP		FAF4010
	MM	İNÇ	FİYAT \$
<ul style="list-style-type: none"> PN10 Basınç Sınıfındadır. TSEK'e uygundur. Gövde ve kapak nikel kaplıdır. Küre krom kaplı pirinçtir. Küre sızdırmazlık elemanı (PTFE) teflondur. Maksimum çalışma sıcaklığı 90°C'dir. 	15	1/2"	11
	20	3/4"	17

01.02.2026

FAF 4020

PİRİNÇ KÜRESEL VANA (E/D) RAKORLU



ÜRÜN ÖZELLİKLERİ	ÇAP		FAF4020
	MM	İNÇ	FİYAT \$
<ul style="list-style-type: none"> • PN10 Basınç Sınıfındadır. • TSEK'e uygundur. • Gövde ve kapak nikel kaplıdır. • Küre krom kaplı pirinçtir. • Küre sızdırmazlık elemanı (PTFE) teflondur. • Maksimum çalışma sıcaklığı 90°C'dir. 	20	3/4"	25
	25	1"	32

FAF 4040

PİRİNÇ KÜRESEL VANA - MİNİ



ÜRÜN ÖZELLİKLERİ	ÇAP		FAF4040
	MM	İNÇ	FİYAT \$
<ul style="list-style-type: none"> • PN10 Basınç Sınıfındadır. • TSEK'e uygundur. • Gövde ve kapak nikel kaplıdır. • Küre krom kaplı pirinçtir. • Küre sızdırmazlık elemanı (PTFE) teflondur. • Maksimum çalışma basıncı 10 bar'dır. • Maksimum çalışma sıcaklığı 90°C'dir. 	5	1/4"	6,5
	10	3/8"	7
	15	1/2"	8,5
	20	3/4"	12

01.02.2026

FAF 4200

PİRİNÇ PİSLİK TUTUCU



ÜRÜN ÖZELLİKLERİ	ÇAP		FAF4200
	MM	İNÇ	FİYAT \$
<ul style="list-style-type: none"> PN16 basınç sınıfındadır. Gövde ve kapak pırınçtır. Filtre paslanmaz çeliktir. Maksimum çalışma sıcaklığı 90°C'dir. 	15	1/2"	13
	20	3/4"	19
	25	1"	30
	32	1 1/4"	43
	40	1 1/2"	58
	50	2"	79

FAF 4350

PİRİNÇ ÇEKVALF - ÇALPARA



ÜRÜN ÖZELLİKLERİ	ÇAP		FAF4350
	MM	İNÇ	FİYAT \$
<ul style="list-style-type: none"> PN16 basınç sınıfındadır. Gövde ve klape pırınçtır. Maksimum çalışma sıcaklığı 90°C'dir. 	15	1/2"	12
	20	3/4"	16
	25	1"	23
	32	1 1/4"	42
	40	1 1/2"	52
	50	2"	73

FAF 4300

PİRİNÇ ÇEKVALF - YAYLI



ÜRÜN ÖZELLİKLERİ	ÇAP		FAF4300
	MM	İNÇ	FİYAT \$
<ul style="list-style-type: none"> PN25 basınç sınıfındadır. Gövde pırınçtır. Klape yayı paslanmaz çeliktir. Maksimum çalışma sıcaklığı 90°C'dir. 	15	1/2"	9
	20	3/4"	13
	25	1"	20
	32	1 1/4"	33
	40	1 1/2"	48
	50	2"	71
	65	2 1/2"	125
	80	3"	162

01.02.2026

FAF 4700

OTOMATİK HAVA TAHLİYE



ÜRÜN ÖZELLİKLERİ	ÇAP		FAF4700
	MM	İNÇ	FİYAT \$
<ul style="list-style-type: none"> PN10 basınç sınıfındadır. Gövde ve kapak pirinçtir. 	15	1/2"	19

FAF 4800

PİRİNÇ BASINÇ DÜŞÜRÜCÜ



ÜRÜN ÖZELLİKLERİ	ÇAP		FAF4800
	MM	İNÇ	FİYAT \$
<ul style="list-style-type: none"> PN16 basınç sınıfındadır. Gövde nikel kaplı pirinçtir. Paslanmaz çelik yaylıdır. 1-6 bar ayarlanabilir basınç aralığındadır. Maksimum çalışma sıcaklığı 80°C'dir. 	15	1/2"	39
	20	3/4"	42
	25	1"	106

FAF 4900

PİRİNÇ EMNİYET VENTİLİ



ÜRÜN ÖZELLİKLERİ	ÇAP		FAF4900
	MM	İNÇ	FİYAT \$
<ul style="list-style-type: none"> PN16 basınç sınıfındadır. Gövde MS58 pirinçtir. Paslanmaz çelik yaylıdır. 1-10 bar ayarlanabilir basınç aralığındadır. Maksimum çalışma sıcaklığı 130°C'dir. 	15	1/2"	54
	20	3/4"	79
	25	1"	103

01.02.2026

PİRİNÇ VANALAR

TS EAC CE TL

		1/2"	3/4"	1"	1 1/4"	1 1/2"	2"	2 1/2"	3"	4"
Pirinç Küresel Vana (R850)		517,50	646,88	1.164,38	1.645,65	2.512,75	3.987,63	-	-	-
Pirinç Küresel Vana (R250D)		-	-	-	-	-	-	8.289,20	11.214,80	23.161,00
Pirinç Küresel Vana (R850T)		464,31	613,81	1.086,75	1.645,65	2.512,75	3.987,63	-	-	-
İzolasyon Boyunlu Pirinç Küresel Vana (R851TH)		940,84	1.170,13	1.864,29	2.443,03	4.021,12	6.029,31	-	-	-
Kelebek Kollu Pirinç Küresel Vana (R851)		543,38	672,75	1.164,38	2.648,36	-	-	-	-	-
Kelebek Kollu Pirinç Küresel Vana (R254D) (İç Diş*Diş Diş)		908,00	1.464,00	2.256,00	3.207,00	-	-	-	-	-
Kelebek Kollu Pirinç Küresel Vana (R859) (İç Diş*Diş Diş Rakorlu)		1.128,00	1.780,80	2.238,60	3.990,00	-	-	-	-	-
Küresel Kosva Vana (R250DS)		1.370,40	1.915,80	2.562,60	3.956,40	5.560,20	8.592,60	-	-	-
Pirinç Küresel Vana (Doğal Gaz) (R730G)		837,60	1.275,60	2.176,20	3.081,00	5.029,20	8.052,60	-	-	-
Mini Küresel Vana (BAV-0104)		421,20	561,60	-	-	-	-	-	-	-
Pirinç Pislik Tutucu (STR-0101)		450,00	584,38	1.093,75	1.719,09	2.315,63	3.510,81	-	-	-
Pirinç Yaylı Çek Vana (CHE-0102)		414,00	534,00	732,00	1.278,26	1.859,52	2.789,28	-	-	-
Pirinç Çalpara Çekvalf (CHE-0101)		898,00	1.300,00	1.690,00	3.000,00	3.800,00	5.300,00	-	-	-
Unival Pirinç Şiber Vana İç Dişli		-	812,00	-	-	-	-	-	-	-
GIACOMINI Pirinç Şiber Vana (R55)		1.020,00	1.337,61	1.670,00	2.790,00	3.790,00	5.600,00	-	-	-
GIACOMINI Küresel Vana İç Dişli (R250W)		1.154,40	1.923,60	3.047,40	4.380,60	6.702,60	10.874,40	-	-	-











01.02.2026

PİRİNÇ VANALAR		   EURO (€)								
		1/2"	3/4"	1"	1 1/4"	1 1/2"	2"	2 1/2"	3"	4"
GIACOMINI Küresel Vana Entegre Filtreli Tam Geçişli (R701F)		31,25	37,50	65,63				-	-	-
GIACOMINI Otomatik Purjör (R88I)		11,12	-	-	-	-	-	-	-	-
GIACOMINI Geri Akış Önleyici (R623)		-	66,51	61,12	-	-	-	-	-	-
GIACOMINI Otomatik Doldurma Vanası (R150)		84,75	-	-	-	-	-	-	-	-
Koç Darbesi Önleme Vanası (OR)		59,30	-	-	-	-	-	-	-	-
Pirinç Basınç Düşürücü (OR)		-	29,69	73,42	133,24	143,39	280,32	-	-	-
GIACOMINI Emniyet Ventili (R140) 2,5 BAR - 3 BAR - 3,5 BAR - 4 BAR - 6 BAR		26,67	36,39	64,77	84,57	-	-	-	-	-
GIACOMINI Fark Basınç Vanası (R147)		-	37,36							

01.02.2026





RADYATÖR VANALARI		TS EAC EURO (€)		
		1/2"	3/4"	1"
Köşe Radyatör Vanası (R705)		13,59		-
Köşe Radyatör Vanası (R5)		16,79		-
Düz Radyatör Vanası (R706)		15,99		-
Düz Radyatör Vanası (R6)		18,44		-
Köşe Termostatik Radyatör Vanası (R401)		15,12	20,05	39,47
Giacomini Termostatik Başlık (R470)		10,88		-
Köşe Dönüş Vanası (R16)		13,73		-
Düz Dönüş Vanası (R17)		15,34		-
Giacomini Termostatik Düz Vana (R402)		15,94	21,66	39,72
Giacomini Köşe Radyatör Vanası (R421)		16,10	22,52	41,59
Giacomini Radyatör Vanası Düz (R422)		17,52	22,52	47,37

01.02.2026

HORTUMLAR		USD (\$)			
		DN 15	DN 20	DN 20 x DN 25	DN 25
İzoleli, Örgüsüz, Fan Coil Hortumu 2,5-10 Bar, 30 cm, RxN (IFH-1001)		11,09	16,07	29,74	28,19
İzoleli, Örgüsüz, Fan Coil Hortumu 2,5-10 Bar, 40 cm, RxN (IFH-1001)		13,01	19,58		31,06
İzoleli, Örgüsüz, Fan Coil Hortumu 2,5-10 Bar, 50 cm, RxN (IFH-1001)		13,88	19,86		32,50
İzoleli, Örgüsüz, Fan Coil Hortumu 2,5-10 Bar, 60 cm, RxN (IFH-1001)		16,75	20,15		
İzoleli, Örgüsüz, Fan Coil Hortumu 2,5-10 Bar, 70 cm, RxN (IFH-1001)		17,04	21,01		35,66
İzoleli Örgülü Fan Coil Hortumu, 25 Bar, 30 cm, RxN (IFH-1002)		11,59	16,62	30,31	28,75
İzoleli Örgülü Fan Coil Hortumu, 25 Bar, 40 cm, RxN (IFH-1002)		13,51	20,13		31,63
İzoleli Örgülü Fan Coil Hortumu, 25 Bar, 50 cm, RxN (IFH-1002)		14,38	20,41		33,06
İzoleli Örgülü Fan Coil Hortumu, 25 Bar, 60 cm, RxN (IFH-1002)		17,25	20,70		-
İzoleli Örgülü Fan Coil Hortumu, 25 Bar, 70 cm, RxN (IFH-1002)		17,54	21,56		36,23
Sprinkler Bağlantılı Hortum, 25 Bar, 50 cm (SPH-0702)		-	-		18,60
Sprinkler Bağlantılı Hortum, 25 Bar, 70 cm (SPH-0702)		-	-		21,09
Sprinkler Bağlantılı Hortum, 25 Bar, 100 cm (SPH-0702)		-	-		21,87



01.02.2026



KELEBEK VANALAR - PN16		TSE EAC CE USD (\$)							
		DN 40	DN 50	DN 65	DN 80	DN 100	DN 125	DN 150	DN 200
Wafer Tip Kelebek Vana, PN 16, Nikel Kl. (BWN-0201)		90,00	93,00	94,54	104,84	140,97	195,03	225,00	347,77
Wafer Tip Kelebek Vana, PN16, Paslanmaz Kl.(BWN-0202)		100,63	109,25	123,63	153,03	189,75	211,57	283,83	492,24
Wafer Tip Kelebek Vana, PN16, Al-Brnz-Kl.(BWN-0203)		-	136,61	160,92	179,31	264,58	342,67	426,70	717,06
Lug Tip Kelebek Vana, PN16, Nikel Kl. (BLN-0201)		100,63	105,30	108,38	135,02	177,07	210,51	260,25	426,76
Lug Tip Kelebek Vana, PN16, Paslanmaz Kl. (BLN-0202)		115,00	117,88	133,90	154,25	193,24	260,97	296,91	562,44
Lug Tip Kelebek Vana, PN16, Al-Brnz Kl. (BLN-0203)		-	205,81	230,48	280,24	417,12	533,68	681,31	1,087.01

KELEBEK VANALAR - PN16 DİŞLİ KUTULU		TSE EAC CE USD (\$)						
		DN 250	DN 300	DN 350	DN 400	DN 450	DN 500	DN 600
Wafer Tip Kelebek Vana, PN16, Nikel Kl. (BWN-0201)		660,00	750,00	2.154,14	4.501,44	4.885,16	7.699,52	10.303,83
Wafer Tip Kelebek Vana, PN16, Paslanmaz Kl. (BWN-0202)		862,50	1.293,75	6.667,11	8.777,34	8.998,96	10.097,00	-
Lug Tip Kelebek Vana, PN16, Nikel Kl.(BLN-0201)		696,34	880,84	1.562,24	2.227,92	5.488,65	6.037,50	9.337,89
Lug Tip Kelebek Vana, PN16, Paslanmaz Kl. (BLN-0202)		862,50	1.293,75	2.926,86	4.415,58	6.786,10	7.759,42	9.796,51

* Aktüatör için fiyat sorunuz.



01.02.2026

KELEBEK VANALAR - PN25		TSE EAC CE USD (\$)						
		DN 50	DN 65	DN 80	DN 100	DN 125	DN 150	DN 200
Wafer Tip Kelebek Vana PN25, Paslanmaz Kl.(BWN-0305)		-	248,89	279,65	357,00	504,36	1.650,00	1.683,62
Lug Tip Kelebek Vana PN25, Paslanmaz Kl. (BLN-0305)		245,70	264,71	322,31	467,62	562,16	839,10	2.068,72

KELEBEK VANALAR - PN25 DİŞLİ KUTULU		TSE EAC CE USD (\$)	
		DN 250	DN 300
Wafer Tip Kelebek Vana PN25, Paslanmaz Kl. (BWN-0305)		1.981,57	3.072,83
Lug Tip Kelebek Vana PN25, Paslanmaz Kl.(BLN-0305)		2.730,00	3.460,00

* Aktüatör için fiyat sorunuz.

DİŞLİ KUTUSU		TSE EAC CE USD (\$)								
		DN 50	DN 65	DN 80	DN 100	DN 125	DN 150	DN 200	DN 250	DN 300
Dişli Kutusu (BGB-0001)		90,00	90,00	90,00	90,00	90,00	90,00	115,00	172,50	172,50

KELEBEK VANALAR - PN16		TSE EAC CE USD (\$)							
		DN 350	DN 400	DN 450	DN 500	DN 600	DN 700	DN 800	DN 900
Flanşlı Kelebek Vana PN16 (BFN-0301)		Fiyat Sorunuz							
Demontaj Parçası PN16 (DJ-0301)		Fiyat Sorunuz							

01.02.2026

PİK DÖKÜM VANALAR

TSE EAC CE TL

		DN 15	DN 20	DN 25	DN 32	DN 40	DN 50	DN 65	DN 80	DN 100	DN 125
Küresel Vana, PN16, PİK Döküm, TG, 2P, (BAV-0201)		-	-	-	3.737,50	5.175,00	5.750,00	7.187,50	10.249,38	14.375,00	24.437,50
Küresel Vana, PN16, PİK Döküm, TG, 3P, (BAV-0302)		5.175,00	5.508,50	6.612,50	8.625,00	8.912,50	9.200,00	13.512,50	16.100,00	23.000,00	31.938,56
Küresel Doğal Gaz Vanası, PN25, Sfero Döküm, TG (BAV-0301)		-	-	-	-	-	-	14.375,00	17.250,00	25.875,00	34.787,50
Pislik Tutucu, PN16, Y Tipi, PİK Döküm (STR-0201)		1.381,38	1.430,72	1.768,15	2.360,17	4.725,04	5.790,43	6.688,39	7.805,53	11.877,31	17.825,00
Disk Tipi Çek Vana, PN16 (CHE-1001)		1.466,25	1.832,81	1.955,00	2.970,00	3.510,00	4.590,00	6.750,00	8.400,00	12.000,00	-
Disk Tipi Çek Vana, PN16, Sfero Döküm (CHE-0301)		-	-	-	-	2.472,50	2.875,00	3.450,00	4.312,50	5.606,25	6.625,47

PİK DÖKÜM VANALAR

TSE EAC CE USD (\$)

		DN 15	DN 20	DN 25	DN 32	DN 40	DN 50	DN 65	DN 80	DN 100	DN 125
Pislik Tutucu, PN25, Y Tipi, Sfero Döküm (STR-0305)		-	-	-	-	-	-	486,09	549,00	757,72	1.091,45
Sürgülü Vana, PN16, Elastomer Sıtlı, Sfero Döküm (GAV-0301)		-	-	-	-	-	182,53	238,69	290,17	393,14	582,69
Glob Vana, PN16, Sfero Döküm (UGV-0301)		197,34	215,28	254,75	345,33	380,33	452,09	660,19	818,05	1.413,67	1.880,11
Yaylı Çek Vana, PN16, Sfero Döküm (CHE-0301)		111,23	132,77	165,05	208,09	254,75	340,86	527,45	688,91	1.112,28	1.614,60
Çalpara Tipi Çek Vana, PN16, Flanşlı, Sfero Döküm (CHE-0310)		-	-	-	-	-	210,61	298,36	358,53	498,94	787,28
Metal Körüklü Vana, PN16, Sfero Döküm (UMKV-0301)		269,68	289,80	336,09	412,56	462,88	563,50	905,63	1.066,63	1.529,50	2.314,38
Disk Tipi Çek Vana, PN16 Paslanmaz (CHE-1015)		-	-	-	-	82,04	107,29	157,77	196,34	280,49	-
Çift Klapeli Disk Çek Vana, PN16 (CHE-1005)		-	-	-	-	75,00	77,73	100,62	152,38	207,27	271,78
Swing Çek Vana, Wafer Tip, PN16 (CHE-1010)		-	-	-	-	70,00	73,87	96,28	123,86	172,56	237,35
Akış Düzenleyici Pislik Tutucu (SD-0201)		Fiyat Sorunuz									

* Redüksiyon geçişi.

01.02.2026

TSE EAC CE TL

PİK DÖKÜM VANALAR

		DN 150	DN 200	DN 250	DN 300	DN 350	DN 400	DN 450	DN 500	DN 600
Küresel Vana, PN16, PİK Döküm, TG, 2P, (BAV-0201)		46.000,00	69.000,00	-	-	-	-	-	-	-
Küresel Vana, PN16, PİK Döküm, TG, 3P, (BAV-0302)		60.000,00	90.000,00	120.750,00*	215.625,00	-	-	-	-	-
Küresel Doğal Gaz Vanası, PN25, Sfero Döküm, TG (BAV-0301)		63.250,00	92.000,00	-	-	-	-	-	-	-
Pislik Tutucu, PN16, Y Tipi, PİK Döküm (STR-0201)		20.700,00	34.500,00	63.250,00	109.250,00	129.375,00	201.250,00	345.000,00	431.250,00	718.750,00
Disk Tipi Çek Vana, PN16 (CHE-1001)		-	-	-	-	-	-	-	-	-
Disk Tipi Çek Vana, PN16, Sfero Döküm (CHE-0301)		10.954,55	16.048,56	-	-	-	-	-	-	-

* Redüksiyon geçişi.

TSE EAC CE USD (\$)

PİK DÖKÜM VANALAR

		DN 150	DN 200	DN 250	DN 300	DN 350	DN 400	DN 450	DN 500	DN 600
Pislik Tutucu, PN25, Y Tipi, Sfero Döküm (STR-0305)		1.578,04	2.612,08	5.715,77	6.267,74	-	-	-	-	-
Sürgülü Vana, PN16, Elastomer Sittli, Sfero Döküm (GAV-0301)		734,80	1.240,26	1.942,30	2.644,33	3.599,10	5.405,67	-	-	-
Glob Vana, PN16, Sfero Döküm (UGV-0301)		2.601,30	5.023,20	-	-	-	-	-	-	-
Yaylı Çek Vana, PN16, Sfero Döküm (CHE-0301)		2.368,08	4.664,40	-	-	-	-	-	-	-
Çalpara Tipi Çek Vana, PN16, Flanşlı, Sfero Döküm (CHE-0310)		977,83	1.669,84	2.597,52	3.705,74	-	-	-	-	-
Metal Körüklü Vana, PN16, Sfero Döküm (UMKV-0301)		3.069,06	5.614,88	-	-	-	-	-	-	-
Disk Tipi Çek Vana, PN25, Paslanmaz (CHE-1015)		-	-	-	-	-	-	-	-	-
Çift Klapeli Disk Çek Vana, PN16 (CHE-1005)		402,18	607,14	1.030,72	1.466,18	2.007,95	2.831,57	3.913,65	5.084,53	-
Swing Çek Vana, Wafer Tip, PN16 (CHE-1010)		297,25	524,98	860,22	1.270,61	-	-	-	-	-
Akış Düzenleyici Pislik Tutucu (SD-0201)		Fiyat Sorunuz								







01.02.2026



**BALANS VANASI VE
KONTROL VANASI**

EURO (€)

		1/2"	3/4"	1"	1 1/4"	1 1/2"	2"	2 1/2"
GIACOMINI Kompakt Tip Statik Balans Vanası, Dişli (R206B-1)		43,59	45,96	49,28	-	-	-	-
GIACOMINI Statik Balans Vanası, Dişli (R206B)		60,84	67,71	72,97	96,28	142,19	172,32	-
GIACOMINI Fark Basınç Kontrol Vanası, Dişli (R206C1)		106,00	112,00	126,43	-	-	-	-
GIACOMINI Fark Basınç Kontrol Vanası (R206C)		273,62	287,84	354,14	369,87	407,45	448,78	-
FLOWCON Dinamik Balans Vanası, Dişli (A)		99,30	99,30	111,46	-	-	-	-
FLOWCON Dinamik Balans Vanası, Dişli (AB)		-	-	-	240,50	460,78	460,78	-
GIACOMINI Fan Coil ON-OFF Vanası (R402+R473E) (motoruyla birlikte)		49,00	55,59	76,42	-	-	-	-
GIACOMINI R206A Kombine Dinamik Balans Vanası (230V ON-OFF Kontrollü) (PICV)		63,75	63,75	100,94	-	-	-	-
FLOWCON ESENTIA Kombine Dinamik Balans Vanası (230V ON-OFF Kontrollü) (PICV)		99,50	104,33	-	-	-	-	-
FLOWCON Kombine Dinamik Balans Vanası (230V ON-OFF Kontrollü) Green (A Gövde)		-	-	265,42	454,30	-	-	-
FLOWCON Kombine Balans Vanası (24V Oransal Kontrollü) Green (A Gövde)		-	-	322,50	-	-	-	-
FLOWCON Kombine Balans Vanası (230V ON-OFF Kontrollü) Green (AB Gövde)		-	-	-	511,38	-	-	-
FLOWCON Kombine Balans Vanası (24V Oransal Kontrollü) Green (AB Gövde- DI)		-	-	-	-	986,74	1.036,15	-
FLOWCON 2 Yollu Kontrol Vanası, Dişli (24V Oransal)		523,63	680,16	768,98	836,68	948,25	1.160,45	1.204,99
FLOWCON 3 Yollu Kontrol Vanası, Dişli (24V Oransal)		638,75	814,93	1.108,42	1.196,82	1.339,97	1.809,34	-
Giacomini R297 3 Yollu Kontrol Vanası, (24V Oransal)		-	176,73	181,82	184,60	354,28	407,00	-
Giacomini R473HEX Aktüatör (230V ON-OFF Kontrollü)		25,00						

01.02.2026

BALANS VANASI VE KONTROL VANASI		EURO (€)										
		DN 50	DN 65	DN 80	DN 100	DN 125	DN 150	DN 200	DN 250	DN 300	DN 350	DN 400
UNIVAL Statik Balans Vanası, Flanşlı (DRV-0201)		506,50	718,96	758,13	1.169,71	1.620,14	1.776,81	2.325,16	5.458,97	10.877,58	-	-
FLOWCON Fark Basınç Kontrol Vanası, Flanşlı (PIM-DP)		2.824,90	2.824,90	4.606,54	4.606,54	6.966,12	6.966,12	-	-	-	-	-
FLOWCON Dinamik Balans Vanası, Wafer		623,94	630,71	630,71	1.262,87	-	2.753,88	4.289,81	6.096,69	7.820,56	10.915,18	14.829,90
FLOWCON Kombine Dinamik Balans Vanası, Flanşlı 24V Oransal		3.730,98	3.730,98	6.352,67	6.352,67	8.740,90	8.740,90	23.868,44	23.868,44	-	-	-
FLOWCON 2 Yollu Kontrol Vanası, Dişli (24V Oransal)		-	-	1.406,86	-	-	-	-	-	-	-	-
FLOWCON 2 Yollu Kontrol Vanası, Flanşlı (24V Oransal)		-	-	-	4.779,62	5.748,88	6.632,00	-	-	-	-	-
FLOWCON 3 Yollu Kontrol Vanası, Flanşlı (24V Oransal)		-	2.291,23	3.559,57	5.762,86	7.155,96	7.970,14	-	-	-	-	-

PASLANMAZ ÇELİK VANALAR		USD (\$)								
		DN 15	DN 20	DN 25	DN 32	DN 40	DN 50			
Paslanmaz Küresel Vana, 2P Dişli (BAV-0602)		25,01	33,40	48,09	72,48	104,33	141,28	-	-	-
Paslanmaz Pislik Tutucu (STR-0601)		114,62	149,88	211,60	308,58	379,12	599,53	-	-	-

PASLANMAZ ÇELİK VANALAR		USD (\$)					
		DN 15	DN 20	DN 25	DN 32	DN 40	DN 50
Paslanmaz Çelik Küresel Vana, 2P Flanşlı (BAV-0601)		692,46	865,58	1.112,88	1.508,58	1.792,98	2.324,69
		DN 65	DN 80	DN 100	DN 125	DN 150	DN 200
		3.338,65	3.956,92	5.317,11	-	-	-

TERMOSTATİK KARIŞTIRMA VANASI		EURO (€)						
		1/2"	3/4"	1"	1 1/4"	1 1/2"	2"	2 1/2"
GIACOMINI R156-2 Termostatik Karıştırma Vanası		-	129,41	182,35	465,00	426,47	1.485,29	-

01.02.2026

RAKOR	EURO (€)
Rakor 1 1/4"x1 1/4"	22,18
Rakor 1"x1"	13,56
Rakor 3/4" x 1/2"	22,06
Rakor 3/4"x3/4"	8,39
Rakor 1 1/2" x 1 1/4"	29,41
Rakor 2" x 1 1/2"	191,18
Rakor 1" x 3/4"	26,47

01.02.2026



TL

KOMPANSATÖR



		DN 15	DN 20	DN 25	DN 32	DN 40	DN 50	DN 65
Döküm Flanşlı Kauçuk Kompansatör PN16 (REJ-0901)		-	-	-	2.346,00	2.732,40	3.118,80	3.919,20
Kauçuk Kompansatör Dişli PN16 (REJ-0902)			1.566,24	1.814,30	2.192,32	2.746,64	3.403,40	6.996,08
Döner Flanşlı Limit Rodlu Titreşim Yutucu PN16 30 mm (UTY-0911)		-	-	5.183,64	5.977,44	6.226,92	7.358,56	8.860,32
Döner Flanşlı Kompansatör, PN16 30 mm Laynersiz (UEJ-0901)		-		3.265,92	3.961,44	4.263,84	4.751,76	5.790,96
Döner Flanşlı Kompansatör, PN16 60 mm Laynersiz (UEJ-0901)		-	-	-	-	-	-	6.199,20
Döner Flanşlı Kompansatör, PN16 30 mm Laynerli (UEJ-0902)		-	-	3.613,68	4.309,20	4.777,92	5.503,68	6.516,72
Döner Flanşlı Kompansatör, PN16 60 mm Laynerli (UEJ-0902)		-	-	-	-	-	-	7.408,80
Sabit Flanşlı Kompansatör, PN16 30 mm Laynersiz (UEJ-0903)		-	-	3.840,00	3.916,08	4.354,56	4.868,64	5.685,12
Sabit Flanşlı Kompansatör, PN16 60 mm Laynersiz (UEJ-0903)		-	-	-	-	-	-	6.756,12
Sabit Flanşlı Kompansatör, PN16 30 mm Laynerli (UEJ-0904)		-	-	4.082,40	4.777,92	5.261,76	5.806,08	6.637,68
Sabit Flanşlı Kompansatör, PN16 60 mm Laynerli (UEJ-0904)		-	-	-	-	-	-	7.592,76
Kaynak Boyunlu Kompansatör, PN16 30 mm Laynersiz (UEJ-0905)		-	-	2.245,32	2.326,97	2.503,87	2.735,21	2.993,76
Kaynak Boyunlu Kompansatör, PN16 60 mm Laynersiz (UEJ-0905)		-	-	-	-	-	3.129,84	3.483,65
Kaynak Boyunlu Kompansatör, PN16 30 mm Laynerli (UEJ-0906)		-	-	3.008,88	3.069,36	3.190,32	3.553,20	3.916,08
Kaynak Boyunlu Kompansatör, PN16 60 mm Laynerli (UEJ-0906)		-	-	-	-	-	-	4.974,48
Dıştan Basıncılı, Kaynak Boyunlu Kompansatör, PN16 30 mm (UEJ-0907)		-	-	6.208,65	6.599,88	7.069,78	8.646,75	8.850,52
Dıştan Basıncılı, Kaynak Boyunlu Kompansatör, PN16 60 mm (UEJ-0907)		-	-	6.923,07	7.047,81	7.562,95	9.287,58	9.644,91
Dıştan Basıncılı, Kaynak Boyunlu Kompansatör, PN16 90 mm (UEJ-0907)		-	-	7.291,62	7.393,68	7.896,66	9.474,57	10.344,80
Dıştan Basıncılı, Kaynak Boyunlu Kompansatör, PN16 120 mm (UEJ-0907)		-	-	-	-	-	-	11.586,65

01.02.2026

KOMPANSATÖR		TL						
		DN 15	DN 20	DN 25	DN 32	DN 40	DN 50	DN 65
Dıştan Basıncılı, Flanşlı Kompansatör, PN16 30 mm (UEJ-0908)		-	-	8.139,29	8.782,83	9.630,14	11.586,65	12.905,16
Dıştan Basıncılı, Flanşlı Kompansatör, PN16 60 mm (UEJ-0908)		-	-	-	-	-	12.876,57	13.633,52
Dıştan Basıncılı, Flanşlı Kompansatör, PN16 90 mm (UEJ-0908)		-	-	-	10.174,82	10.614,24	13.341,51	15.063,89
Dıştan Basıncılı, Flanşlı Kompansatör, PN16 120 mm (UEJ-0908)		-	-	-	11.889,99	12.309,57	14.727,83	16.046,10





KOMPANSATÖR		TL						
		DN 80	DN 100	DN 125	DN 150	DN 200	DN 250	DN 300
Döküm Flanşlı Kauçuk Kompansatör PN 16 (REJ-0901)		4.692,00	5.906,40	7.424,40	9.384,00	12.585,60	17.664,00	27.434,40
Kauçuk Kompansatör Dişli PN16 (REJ-0902)		-	-	-	-	-	-	-
Döner Flanşlı Limit Rodlu Titreşim Yutucu PN16 30 mm (UTY-0911)		10.251,36	11.990,16	14.424,48	17.750,88	23.511,60	35.864,64	-
Döner Flanşlı Kompansatör, PN16 30 mm Laynersiz (UEJ-0901)		6.453,74	7.882,56	9.641,52	11.088,00	16.170,86	28.302,14	38.253,60
Döner Flanşlı Kompansatör, PN16 60 mm Laynersiz (UEJ-0901)		6.960,24	8.444,52	10.306,80	12.118,68	18.113,76	31.767,12	40.965,12
Döner Flanşlı Kompansatör, PN16 30 mm Laynerli (UEJ-0902)		7.577,64	9.412,20	10.742,76	12.453,84	18.209,52	31.051,44	41.771,52
Döner Flanşlı Kompansatör, PN16 60 mm Laynerli (UEJ-0902)		8.242,92	10.148,04	12.327,84	14.500,08	21.631,68	36.197,28	-
Sabit Flanşlı Kompansatör, PN16 30 mm Laynersiz (UEJ-0903)		6.819,12	8.545,32	10.236,24	11.775,96	16.745,40	28.765,80	37.227,96
Sabit Flanşlı Kompansatör, PN16 60 mm Laynersiz (UEJ-0903)		7.489,44	8.958,60	10.823,40	12.554,64	18.564,84	31.941,00	-
Sabit Flanşlı Kompansatör, PN16 30 mm Laynerli (UEJ-0904)		7.852,32	8.600,00	9.404,64	11.287,08	13.046,04	18.544,68	-
Sabit Flanşlı Kompansatör, PN16 60 mm Laynerli (UEJ-0904)		8.414,28	10.160,64	12.259,80	14.288,40	21.115,08	34.770,96	-
Kaynak Boyunlu Kompansatör, PN16 30 mm Laynersiz (UEJ-0905)		3.470,04	4.422,60	5.538,46	7.103,38	9.443,95	13.539,96	-
Kaynak Boyunlu Kompansatör, PN16 60 mm Laynersiz (UEJ-0905)		3.839,72	4.756,00	6.039,68	7.518,42	11.305,98	16.799,08	-

01.02.2026

KOMPANSATÖR		TL						
		DN 80	DN 100	DN 125	DN 150	DN 200	DN 250	DN 300
Kaynak Boyunlu Kompansatör, PN16 30 mm Laynerli (UEJ-0906)		4.536,00	5.987,52	7.242,48	9.044,28	12.252,24	17.796,24	-
		5.440,68	6.889,76	8.643,60	10.934,28	15.140,16	22.281,84	-
Dıştan Basıncılı, Kaynak Boyunlu Kompansatör, PN16 30 mm (UEJ-0907)		10.436,34	12.636,42	18.480,66	23.703,44	35.380,80	46.196,33	58.582,44
Dıştan Basıncılı, Kaynak Boyunlu Kompansatör, PN16 60 mm (UEJ-0907)		11.644,17	14.677,03	20.321,28	27.550,53	40.670,91	57.340,71	73.332,95
Dıştan Basıncılı, Kaynak Boyunlu Kompansatör, PN16 90 mm (UEJ-0907)		12.116,79	16.074,45	23.397,26	30.447,90	41.606,46	60.717,20	77.228,24
Dıştan Basıncılı, Kaynak Boyunlu Kompansatör, PN16 120 mm (UEJ-0907)		14.016,24	18.711,00	27.094,10	34.309,17	52.467,35	-	-
Dıştan Basıncılı, Flanşlı Kompansatör, PN16 30 mm (UEJ-0908)		15.214,50	18.755,30	25.115,27	31.740,66	45.439,38	70.957,22	-
Dıştan Basıncılı, Flanşlı Kompansatör, PN16 60 mm (UEJ-0908)		16.968,66	19.932,89	28.758,24	36.591,35	52.240,55	82.217,84	-
Dıştan Basıncılı, Flanşlı Kompansatör, PN16 90 mm (UEJ-0908)		18.090,84	22.634,64	30.887,33	40.617,05	59.166,45	82.969,11	118.219,50
Dıştan Basıncılı, Flanşlı Kompansatör, PN16 120 mm (UEJ-0908)		19.167,44	25.302,38	35.250,39	43.349,99	66.679,20	107.894,43	-

KOMPANSATÖR		TL											
		DN 15	DN 20	DN 25	DN 32	DN 40	DN 50	DN 65	DN 80	DN 100	DN 125	DN 150	DN 200
Omega Flex (Flanşlı) XYZ: ±50mm		Fiyat Sorunuz											
Omega Flex (Kaynaklı-Yivli) XYZ: ±50mm		Fiyat Sorunuz											

01.02.2026

KOMPANSATÖR		TL										
		DN 32	DN 40	DN 50	DN 65	DN 80	DN 100	DN 125	DN 150	DN 200	DN 250	DN 300
Dilatasyon ve Sismik Kompansatör (Kaynaklı) X: ±50 Y,Z: ±50 (UDJ-0901)		9.396,00	9.715,00	11.693,00	12.640,00	14.922,00	20.788,00	25.422,00	35.266,00	58.102,00	71.771,00	103.924,00
Dilatasyon ve Sismik Kompansatör (Kaynaklı) X: ±50 Y,Z: ±100 (UDJ-0901)		9.737,00	10.077,00	12.101,00	13.214,00	15.683,00	21.853,00	27.062,00	37.642,00	61.215,00	75.939,00	-
Dilatasyon ve Sismik Kompansatör (Kaynaklı) X: ±50 Y,Z: ±150 (UDJ-0901)		10.339,41	10.717,41	12.884,12	14.393,65	17.002,59	23.828,82	29.923,76	41.503,41	71.066,47	88.629,88	-
Dilatasyon ve Sismik Kompansatör (Kaynaklı) X: ±50 Y,Z: ±200 (UDJ-0901)		10.539,00	10.932,00	13.202,00	15.028,00	17.825,00	24.768,00	31.931,00	44.407,00	74.126,00	92.806,00	-
Dilatasyon ve Sismik Kompansatör (Flanşlı) X: ±50 Y,Z: ±50 (UDJ-0902)		11.461,00	11.92700	16.023,00	16.455,00	20.788,00	26.862,00	33.628,00	45.450,00	71.701,00	94.607,00	-
Dilatasyon ve Sismik Kompansatör (Flanşlı) X: ±50 Y,Z: ±100 (UDJ-0902)		11.792,00	12.302,00	16.516,00	16.994,00	21.643,00	28.091,00	34.937,00	47.25100	74.241,00	97.872,00	-
Dilatasyon ve Sismik Kompansatör (Flanşlı) X: ±50 Y,Z: ±150 (UDJ-0902)		12.159,00	12.688,00	17.054,00	17.861,00	20.496,00	29.518,00	37.091,00	49.826,00	82.293,00	107.974,00	-
Dilatasyon ve Sismik Kompansatör (Flanşlı) X: ±50 Y,Z: ±200 (UDJ-0902)		12.603,00	13.120,00	17.745,00	18.844,00	24.333,00	30.899,00	39.678,00	53.760,00	86.964,00	114.012,00	-
Dilatasyon Kompansatör (Flanşlı) X: 30 Y: 25 (UDJ-0906)		7.595,00	8.075,00	10.488,00	-	-	-	-	-	-	-	-
Dilatasyon Kompansatör (Flanşlı) X: 30 Y: 50 (UDJ-0906)		7.840,00	8.346,00	10.828,00	-	-	-	-	-	-	-	-
Dilatasyon Kompansatör (Flanşlı) X: 30 Y: ±75 (UDJ-0906)		8.107,00	8.626,00	11.166,00	-	-	-	-	-	-	-	-
Dilatasyon Kompansatör (Flanşlı) X: 30 Y: 100 (UDJ-0906)		8.351,00	8.884,00	11.507,00	-	-	-	-	-	-	-	-
Dilatasyon Kompansatör (Flanşlı) X: 60 Y: 25 (UDJ-0906)		-	-	-	11.763,00	15.204,00	17.955,00	24.485,00	29.648,00	49.592,00	79.847,00	-
Dilatasyon Kompansatör (Flanşlı) X: 60 Y: 50 (UDJ-0906)		-	-	-	12.186,00	15.789,00	18.622,00	26.463,00	32.071,00	54.332,00	85.771,00	-
Dilatasyon Kompansatör (Flanşlı) X: 60 Y: 75 (UDJ-0906)		-	-	-	12.594,00	16.364,00	19.382,00	27.31800	32.914,00	56.228,00	89.376,00	-
Dilatasyon Kompansatör (Flanşlı) X: 60 Y: 100 (UDJ-0906)		-	-	-	13.016,00	16.866,00	20.121,00	28.219,00	34.012,00	58.802,00	92.021,00	-
Dilatasyon Kompansatör (Kaynaklı) X: 30 Y: 25 (UDJ-0907)		6.890,00	6.974,00	8.268,00	-	-	-	-	-	-	-	-
Dilatasyon Kompansatör (Kaynaklı) X: 30 Y: 50 (UDJ-0907)		7.138,00	7.25200	8.587,00	-	-	-	-	-	-	-	-
Dilatasyon Kompansatör (Kaynaklı) X: 30 Y: 75 (UDJ-0907)		7.428,00	7.556,00	8.930,00	-	-	-	-	-	-	-	-
Dilatasyon Kompansatör (Kaynaklı) X: 30 Y: 100 (UDJ-0907)		7.677,00	7.819,00	9.249,00	-	-	-	-	-	-	-	-
Dilatasyon Kompansatör (Kaynaklı) X: 60 Y: 25 (UDJ-0907)		-	-	-	8.992,00	10.897,00	13.017,00	16.669,00	20.211,00	38.126,00	51.776	-
Dilatasyon Kompansatör (Kaynaklı) X: 60 Y: 50 (UDJ-0907)		-	-	-	9.177,00	11.179,00	13.391,00	18.177,00	22.039,00	41.704,00	56.428,00	-
Dilatasyon Kompansatör (Kaynaklı) X: 60 Y: 75 (UDJ-0907)		-	-	-	9.587,00	11.729,00	14.115,00	19.148,00	23.176,00	43.916,00	59.493,00	-
Dilatasyon Kompansatör (Kaynaklı) X: 60 Y: 100 (UDJ-0907)		-	-	-	9.973,00	12.207,00	14.760,00	20.085,00	24.205,00	46.186,00	61.753,00	-

01.02.2026



**O.K. YAYLI-AĞR.EMNİYET VENTİLİ
GGG-25 PİK DÖKÜM**

**O.K. YAYLI-AĞR.EMNİYET VENTİLİ
GGG 40.3 SFERO DÖKÜM**

**TAM K. YAYLI EMNİYET VENTİLİ
GGG 40.3 SFERO DÖKÜM**

DN	FİYATI
DN25	7.060,00 TL.
DN32	7.835,00 TL.
DN40	8.965,00 TL.
DN50	11.075,00 TL.
DN65	15.160,00 TL.
DN80	20.400,00 TL.
DN100	31.150,00 TL.

DN	FİYATI
DN25	8.575,00 TL.
DN32	9.500,00 TL.
DN40	11.425,00 TL.
DN50	13.600,00 TL.
DN65	18.215,00 TL.
DN80	25.050,00 TL.
DN100	37.460,00 TL.

DN	FİYATI
DN25/40	10.190,00 TL.
DN32/50	11.665,00 TL.
DN40/65	13.215,00 TL.
DN50/80	16.300,00 TL.
DN65/100	22.600,00 TL.
DN80/125	31.100,00 TL.
DN100/150	50.765,00 TL.



**FLANŞLI KONDENSTOP
GGG-25 PİK DÖKÜM**

**DİŞLİ KONDENSTOP
GGG-25 PİK DÖKÜM**

DN	FİYATI
DN15	4.970,00 TL.
DN20	5.500,00 TL.
DN25	7.000,00 TL.
DN32	8.165,00 TL.
DN40	11.330,00 TL.
DN50	15.230,00 TL.

DN	FİYATI
1/2"	4.400,00 TL.
3/4"	4.650,00 TL.
1"	6.100,00 TL.
1 1/4"	7.515,00 TL.
1 1/2"	10.565,00 TL.
2"	12.430,00 TL.



**365 GÜN
UYGUN FİYATLI
MEKANİK ÇÖZÜMLER**
mekaniksepeti.com'da



PRINÇ VANA VE BORU EK PARÇALARI
FİYAT LİSTESİ



1986'dan beri

serdaroglu[®]

TESİSAT TEKNİK MALZEME SAN. TİC. A.Ş.

10.03.2025

YENİ SERİ

ENDÜSTRİYEL TİP PN 25

TS EN 13547 PN 25



KOD NO	BÜYÜKLÜĞÜ	İÇME SUYU KÜRESEL VANASI PN 10	FİYAT / AD.
3310	1/2"	100	178,00
3320	3/4"	50	316,00
3330	1"	40	438,00
3340	1¼"	25	682,00
3350	1½"	15	1.074,00
3360	2"	10	1.620,00
3370	2½"	6	---

KÜRESEL VANA PN 16



KOD NO	BÜYÜKLÜĞÜ	FİYAT / AD.
2208	1/4"	100 132,00
2210	1/2"	100 169,00
2220	3/4"	60 270,00
2230	1"	50 344,00
2240	1¼"	30 614,00
2250	1½"	15 944,00
2260	2"	10 1.462,00
2270	2½"	6 ---

ENDÜSTRİYEL TİP PN 25

TS EN 13547 PN 25



KOD NO	BÜYÜKLÜĞÜ	FİYAT / AD.
329	1/4"	100 160,00
330	3/8"	100 171,00
331	1/2"	70 220,00
3320	3/4"	50 316,00
333	1"	30 524,00
334	1¼"	20 760,00
335	1½"	12 1.210,00
3365	2"	10 1.853,00
337	2½"	4 3.230,00
338	3"	4 4.300,00
339	4"	2 8.126,00

İÇME SUYU KÜRESEL VANASI PN 10

TS EN 13828 PN 10



KOD NO	BÜYÜKLÜĞÜ	FİYAT / AD.
321	1/2"	70 223,00
322	3/4"	50 342,00
323	1"	30 548,00
324	1¼"	20 867,00
325	1½"	12 1.355,00
326	2"	10 2.092,00

ENDÜSTRİYEL TİP PN 40

TS EN 13547 PN 40



KOD NO	BÜYÜKLÜĞÜ	FİYAT / AD.
203	1/2"	60 307,00
204	3/4"	40 481,00
205	1"	25 777,00
206	1¼"	12 1.271,00
207	1½"	10 1.831,00
208	2"	10 2.114,00

MİNİ KÜRESEL VANA ERKEKxDİŞİ



Yeni Seri



Yeni Seri

KOD NO	BÜYÜKLÜĞÜ	FİYAT / AD.
601	1/8"	250 126,00
6020	1/4"	250 100,00
602	1/4"	250 131,00
603	3/8"	250 116,00
6040	1/2"	200 130,00
604	1/2"	200 149,00
605	3/4"	100 220,00
602DD	1/4"	250 100,00
604DD	1/2"	250 147,00

MİNİ KÜRESEL VANA DİŞİ xDİŞİ

TEFLON SALMASTRALI BUHAR TESİSATLARI İÇİN PN 40

Maksimum 120°C



TEFLON SALMASTRALI

BUHAR TESİSATLARI İÇİN PN 25 Yeni Seri

Maksimum 120°C

KOD NO	BÜYÜKLÜĞÜ	FİYAT / AD.
329B	1/4"	100 173,00
330B	3/8"	100 185,00
3310B	1/2"	100 193,00
3320B	3/4"	50 342,00
3330B	1"	40 470,00
3340B	1¼"	25 722,00

KOD NO	BÜYÜKLÜĞÜ	FİYAT / AD.
203B	1/2"	60 332,00
204B	3/4"	40 520,00
205B	1"	25 832,00
206B	1¼"	12 1.348,00
207B	1½"	10 1.923,00

33

33

10.03.2025

**YENİ SERİ
ENDÜSTRİYEL TİP PN 25**

TS EN 13547 PN 25



KOD NO	BÜYÜKLÜĞÜ	AD.	FİYAT / AD.
3310	1/2"	100	178,00
3320	3/4"	50	316,00
3330	1"	40	438,00
3340	1¼"	25	682,00
3350	1½"	15	1.074,00
3360	2"	10	1.620,00
3370	2½"	6	---

KÜRESEL VANA PN 16

KOD NO	BÜYÜKLÜĞÜ	AD.	FİYAT / AD.
2208	1/4"	100	132,00
2210	1/2"	100	169,00
2220	3/4"	60	270,00
2230	1"	50	344,00
2240	1¼"	30	614,00
2250	1½"	15	944,00
2260	2"	10	1.462,00
2270	2½"	6	---

ENDÜSTRİYEL TİP PN 25

TS EN 13547 PN 25



KOD NO	BÜYÜKLÜĞÜ	AD.	FİYAT / AD.
329	1/4"	100	160,00
330	3/8"	100	171,00
331	1/2"	70	220,00
3320	3/4"	50	316,00
333	1"	30	524,00
334	1¼"	20	760,00
335	1½"	12	1.210,00
3365	2"	10	1.853,00
337	2½"	4	3.230,00
338	3"	4	4.300,00
339	4"	2	8.126,00

**İÇME SUYU KÜRESEL
VANASI PN 10**

TS EN 13828 PN 10



KOD NO	BÜYÜKLÜĞÜ	AD.	FİYAT / AD.
321	1/2"	70	223,00
322	3/4"	50	342,00
323	1"	30	548,00
324	1¼"	20	867,00
325	1½"	12	1.355,00
326	2"	10	2.092,00

ENDÜSTRİYEL TİP PN 40

TS EN 13547 PN 40



KOD NO	BÜYÜKLÜĞÜ	AD.	FİYAT / AD.
203	1/2"	60	307,00
204	3/4"	40	481,00
205	1"	25	777,00
206	1¼"	12	1.271,00
207	1½"	10	1.831,00
208	2"	10	2.114,00

**MİNİ KÜRESEL VANA
ERKEKxDİŞİ**

Yeni Seri



Yeni Seri

KOD NO	BÜYÜKLÜĞÜ	AD.	FİYAT / AD.
601	1/8"	250	126,00
6020	1/4"	250	100,00
602	1/4"	250	131,00
603	3/8"	250	116,00
6040	1/2"	200	130,00
604	1/2"	200	149,00
605	3/4"	100	220,00
602DD	1/4"	250	100,00
604DD	1/2"	250	147,00

**MİNİ KÜRESEL VANA
DİŞİ xDİŞİ**
TEFLON SALMASTRALI

 BUHAR TESİSATLARI İÇİN
 PN 25 Yeni Seri

Maksimum 120°C



KOD NO	BÜYÜKLÜĞÜ	AD.	FİYAT / AD.
329B	1/4"	100	173,00
330B	3/8"	100	185,00
3310B	1/2"	100	193,00
3320B	3/4"	50	342,00
3330B	1"	40	470,00
3340B	1¼"	25	722,00
3350B	1½"	15	1.138,00
3360B	2"	10	1.701,00

TEFLON SALMASTRALI

 BUHAR TESİSATLARI İÇİN
 PN 40

Maksimum 120°C



KOD NO	BÜYÜKLÜĞÜ	AD.	FİYAT / AD.
203B	1/2"	60	332,00
204B	3/4"	40	520,00
205B	1"	25	832,00
206B	1¼"	12	1.348,00
207B	1½"	10	1.923,00

10.03.2025

**KOLLU
KÜRESEL VANA TARIMSAL**
301EEK 1/2"x1/2" 100 **174,00**40101 1/2"x3/8" 100 **177,00**

KOD NO	BÜYÜKLÜĞÜ	FIYAT / AD.
--------	-----------	-------------

**DIŞ x DIŞ DIŞLI BAĞLANTILI
TAM GEÇİŞLİ KELEBEK KOLLU**
303EE 1"x1" 30 **340,00**302EE 3/4"x3/4" 50 **295,00**301EE 1/2"x1/2" 100 **174,00**

KOD NO	BÜYÜKLÜĞÜ	FIYAT / AD.
--------	-----------	-------------

335E ve 336E Çelik Kollu olarak üretilir.

**DIŞ x İÇ DIŞLI BAĞLANTILI
TAM GEÇİŞLİ KELEBEK KOLLU**

336E	2"	10	1.876,00
335E	1½"	12	1.215,00
334EK	1¼"	30	775,00
2230EK	1"	50	359,00
2220EK	¾"	60	291,00
2210EK	½"	100	177,00

KOD NO	BÜYÜKLÜĞÜ	FIYAT / AD.
--------	-----------	-------------

**İÇ x İÇ DIŞLI BAĞLANTILI
KELEBEK KOLLU**
2240K 1¼" 30 **614,00**2230K 1" 50 **344,00**2220K ¾" 60 **270,00**2210K ½" 100 **169,00**

KOD NO	BÜYÜKLÜĞÜ	FIYAT / AD.
--------	-----------	-------------

DÜZ RAKORLU
AĞIR TİP 303RE 1" 30 **600,00**2240R 1¼" 30 **831,00**2230R 1" 50 **526,00**2220R ¾" 60 **400,00**2210R ½" 100 **295,00**

KOD NO	BÜYÜKLÜĞÜ	FIYAT / AD.
--------	-----------	-------------

KÖŞE RAKORLU
303RK 1" 30 **554,00**

KOD NO	BÜYÜKLÜĞÜ	FIYAT / AD.
--------	-----------	-------------

Kilitli 5210K ¾" x ½" 50 **291,00**5210 ¾" x ½" 50 **285,00**

¾" X ½" MOP 0,5

KOD NO	BÜYÜKLÜĞÜ	FIYAT / AD.
--------	-----------	-------------

**MOP 0,5 TAM GEÇİŞLİ
KİLİTLİ TİP**
526 2" 10 **1.892,00**525 1½" 12 **1.145,00**524 1¼" 20 **727,00**523 1" 30 **491,00**522 ¾" 50 **307,00**521 ½" 70 **213,00**

KOD NO	BÜYÜKLÜĞÜ	FIYAT / AD.
--------	-----------	-------------

12E

**PN 10
TERMOSTATİK TİP
KONDENSTOP**
104 Paslanmaz Çelik Körük 12 **2.930,00**103 1" 12 **4.720,00**102 ¾" 15 **4.285,00**101 ½" 15 **3.720,00**

KOD NO	BÜYÜKLÜĞÜ	FIYAT / AD.
--------	-----------	-------------

12E

**MOP 0,5 TAM GEÇİŞLİ
KİLİTLİ TİP**
523K 1" 30 **497,00**522K ¾" 50 **313,00**521K ½" 70 **219,00**

KOD NO	BÜYÜKLÜĞÜ	FIYAT / AD.
--------	-----------	-------------

10.03.2025

KENDİNDEN VANALI 1" KOLLEKTÖR GRUBU

TSE K 534

TSEK

Kendinden Vanalı Pirinç

KOD NO	ÇIKIŞ AD.	ÇİFT	NİKEL KAPLI	FİYAT / AD.
662NE	2	30		528,00
663NE	3	20		746,00
664NE	4	10		964,00
665NE	5	10		1.180,00
666NE	6	10		1.397,00
667NE	7	10		1.613,00
668NE	8	10		1.826,00
669NE	9	10		2.045,00
670NE	10	10		2.262,00
671NE	11	10		2.477,00
672NE	12	10		2.695,00

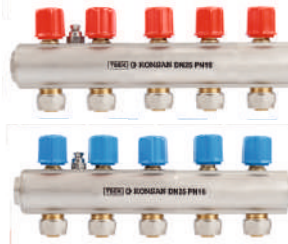
KENDİNDEN VANALI 1" KOLLEKTÖR GRUBU

Ke Alüminyum

KOD NO	ÇIKIŞ AD.	ÇİFT	ELOKSAL KAPLI	FİYAT / AD.
662A	2	30		383,00
663A	3	20		536,00
664A	4	10		689,00
665A	5	10		841,00
666A	6	10		992,00
667A	7	10		1.143,00
668A	8	10		1.297,00
669A	9	10		1.448,00
670A	10	10		1.600,00
671A	11	10		1.751,00
672A	12	10		1.902,00

RAKORLU MİNİ VANA ÇIKIŞLI 1" KOLLEKTÖR GRUBU

TSE K 534

TSEK

Rakorlu Mini Vanalı Pirinç

KOD NO	ÇIKIŞ AD.	ÇİFT	NİKEL KAPLI	FİYAT / AD.
680NE	2	20		627,00
681NE	3	20		890,00
682NE	4	10		1.154,00
683NE	5	10		1.416,00
684NE	6	10		1.678,00
685NE	7	10		1.940,00
686NE	8	10		2.198,00
687NE	9	10		2.462,00
688NE	10	10		2.724,00
689NE	11	10		2.985,00
690NE	12	10		3.248,00

RAKORLU MİNİ VANA ÇIKIŞLI 1" DIŞ DIŞLI KOLLEKTÖR GRUBU

TSE K 534

TSEK

Rakorlu Mini Vanalı Dış Dışlı Pirinç 1"

KOD NO	ÇIKIŞ AD.	ÇİFT	NİKEL KAPLI	FİYAT / AD.
640DM	2	20		564,00
641DM	3	20		801,00
642DM	4	10		1.039,00
643DM	5	10		1.274,00
644DM	6	10		1.510,00
645DM	7	10		1.746,00
646DM	8	10		1.983,00
647DM	9	10		2.219,00
648DM	10	10		2.454,00
649DM	11	10		2.689,00
650DM	12	10		2.925,00

DIŞ DIŞLI KENDİNDEN VANALI 1" PİRİNÇ KOLLEKTÖR GRUBU

TSE K 534

TSEK

Kendinden Vanalı Dış Dışlı Pirinç 1"

KOD NO	ÇIKIŞ AD.	ÇİFT	NİKEL KAPLI	FİYAT / AD.
640DK	2	30		477,00
641DK	3	20		671,00
642DK	4	10		865,00
643DK	5	10		1.058,00
644DK	6	10		1.250,00
645DK	7	10		1.442,00
646DK	8	10		1.636,00
647DK	9	10		1.829,00
648DK	10	10		2.021,00
649DK	11	10		2.212,00
650DK	12	10		2.405,00

KOLLEKTÖR DOLABI

KOD NO	BÜYÜKLÜĞÜ	ÇİFT	FİYAT / AD.
855	40 cm	1	1.050,00
856	60 cm	1	1.150,00
857	80 cm	1	1.750,00
858	100 cm	1	2.040,00

KOLLEKTÖR KELEPÇESİ

KOD NO	BÜYÜKLÜĞÜ	ÇİFT	FİYAT / AD.
638	1" Ağır Tip	100	84,00
6380	1" Standart Tip	100	70,00

KÜRESEL KALORİMETRE VANASI

KOD NO	CİNSİ	ÇİFT	FİYAT / AD.
303T	Rakorsuz	1"	40 475,00
303TREK	Rakorlu	1"	30 606,00

TIRTIKLI PURJÖR (MEKANİK)

KOD NO	BÜYÜKLÜĞÜ	ÇİFT	FİYAT / AD.
9150	1/4"	100	39,00

10.03.2025

KÜRESEL KOSVA VANA PN 16



TSE K 242

TSEK

KOD NO	BÜYÜKLÜĞÜ	AD	FİYAT / AD.
221KV	1/2"	70	340,00
222KV	3/4"	50	450,00
223KV	1"	30	655,00
224KV	1¼"	20	935,00
225KV	1½"	12	1.455,00
226KV	2"	10	2.000,00

ŞİBER VANA



TSE

TS EN 12288

KOD NO	BÜYÜKLÜĞÜ	AD	FİYAT / AD.
451	1/2"	100	273,00
452	3/4"	70	350,00
453	1"	50	568,00
454	1¼"	30	930,00
455	1½"	25	1.248,00
456	2"	10	1.943,00
Eko 4520	3/4"	100	295,00

KAZAN DOLDURMA
BOŞALTMA VANASI

KOD NO	BÜYÜKLÜĞÜ	AD	FİYAT / AD.
707	1/2"	100	286,00

STOP VANA



TSE

KOD NO	BÜYÜKLÜĞÜ	AD	FİYAT / AD.
4521	1/2"	100	273,00
4522	3/4"	70	350,00
4523	1"	50	563,00

İKİ PARÇALI KİLİTLİ
304 PASLANMAZ
KÜRESEL VANA PN 63

KOD NO	BÜYÜKLÜĞÜ	AD	FİYAT \$/AD.
2010	DN 6	1/4"	12,80 \$
2020	DN 10	3/8"	12,80 \$
2030	DN 15	1/2"	12,80 \$
2040	DN 20	3/4"	18,40 \$
2050	DN 25	1"	24,90 \$
2060	DN 32	1¼"	39,00 \$
2070	DN 40	1½"	54,00 \$
2080	DN 50	2"	74,00 \$
2090	DN 65	2½"	165,00 \$
2100	DN 80	3"	240,00 \$

ÜNİVERSAL ÇEK VALF
İÇ DİŞLİ PN 25

TSE

KOD NO	BÜYÜKLÜĞÜ	AD	FİYAT / AD.
801S	1/2"	150	153,00
802S	3/4"	100	228,00
803S	1"	50	338,00
804S	1¼"	30	563,00
805S	1½"	30	816,00
806S	2"	20	1.319,00
807S	2½"	10	2.068,00
808S	3"	4	2.756,00

ÜNİVERSAL ÇEK VALF
DIŞ DİŞLİ PN 25

TSE

KOD NO	BÜYÜKLÜĞÜ	AD	FİYAT / AD.
803SE	1"	50	350,00
804SE	1¼"	30	580,00
805SE	1½"	30	810,00
806SE	2"	20	1.315,00

PİSLİK TUTUCU FİLTRE
PN 16

KOD NO	BÜYÜKLÜĞÜ	AD	FİYAT / AD.
811	1/2"	100	162,00
812	3/4"	75	252,00
813	1"	40	378,00
814	1¼"	20	705,00
815	1½"	20	836,00
816	2"	12	1.275,00
817	2½"	4	2.222,00
818	3"	2	3.117,00
819	4"	1	6.151,00

ÇALPARA ÇEK VALF
PN 16

KOD NO	BÜYÜKLÜĞÜ	AD	FİYAT / AD.
821	1/2"	100	218,00
822	3/4"	60	270,00
823	1"	30	409,00
824	1¼"	20	710,00
825	1½"	15	910,00
826	2"	10	1.240,00
827	2½"	5	2.020,00
828	3"	4	2.820,00

NİSAN 2026

EMNİYET VENTİLİ

İç Dişli

ÜRÜN KODU	ÜRÜN ÖLÇÜSÜ	BAR	KOLİ ADEDİ	FİYATI
07151	1/2" - 1/2"	2,5-3-4-5-6	20	329.00 ₺
07151	1/2" - 1/2"	7-8-9-10	20	349.00 ₺
07201	3/4" - 3/4"	2,5-3-4-5-6	20	576.00 ₺
07201	3/4" - 3/4"	7-8-9-10	20	607.00 ₺
07251	1" - 1"	2,5-3-4-5-6	15	996.00 ₺
07251	1" - 1"	7-8-9-10	15	1,050.00 ₺

EMNİYET VENTİLİ

Dış Dişli

ÜRÜN KODU	ÜRÜN ÖLÇÜSÜ	BAR	KOLİ ADEDİ	FİYATI
07152	1/2" - 1/2"	2,5-3-4-5-6	20	329.00 ₺
07152	1/2" - 1/2"	7-8-9-10	20	349.00 ₺
07202	3/4" - 3/4"	2,5-3-4-5-6	20	576.00 ₺
07202	3/4" - 3/4"	7-8-9-10	20	607.00 ₺
07252	1" - 1"	2,5-3-4-5-6	15	996.00 ₺
07252	1" - 1"	7-8-9-10	15	1,050.00 ₺

EMNİYET VENTİLİ

Manometre Bağlantılı ve İç Dişli

ÜRÜN KODU	ÜRÜN ÖLÇÜSÜ	BAR	KOLİ ADEDİ	FİYATI
26151	1/2" - 1/2"	2,5-3-4-5-6	20	468.00 ₺
26151	1/2" - 1/2"	7-8-9-10	20	499.00 ₺
27151	1/2" - 1/2"	2,5-3-4-5-6	25	884.00 ₺
27151	1/2" - 1/2"	7-8-9-10	25	917.00 ₺

Manometreli

Manometreli



NİSAN 2026

EMNİYET VENTİLİ

İç Dişli

ÜRÜN KODU	ÜRÜN ÖLÇÜSÜ	BAR	KOLİ ADEDİ	FİYATI
08151	1/2" - 3/4"	2,5-3-4-5-6	20	514.00 ₺
08151	1/2" - 3/4"	7-8-9-10	20	544.00 ₺
08201	3/4" - 1"	2,5-3-4-5-6	15	705.00 ₺
08201	3/4" - 1"	7-8-9-10	15	745.00 ₺
07321	1 1/4" - 1 1/2"	2,5-3-4-5-6	5	2,721.00 ₺
07321	1 1/4" - 1 1/2"	7-8-9-10	5	2,864.00 ₺
07401	1 1/2" - 2"	2,5-3-4-5-6	ADET	7,590.00 ₺
07401	1 1/2" - 2"	7-8-9-10	ADET	7,954.00 ₺
07501	2" - 2 1/2"	2,5-3-4-5-6	ADET	9,776.00 ₺
07501	2" - 2 1/2"	7-8-9-10	ADET	10,244.00 ₺



HAVA TAHLİYE CİHAZI

ÜRÜN KODU	ÜRÜN ÖLÇÜSÜ	KOLİ ADEDİ	FİYATI	
4308	1/4"	60	406.00 ₺	
4310	3/8"	60	415.00 ₺	
4315	1/2"	60	422.00 ₺	
1310	1/4" - 3/8"	60	493.00 ₺	kapama valfli
1315	1/4" - 1/2"	60	493.00 ₺	kapama valfli
5315	1/2" - 1/2"	60	557.00 ₺	kapama valfli
6315	1/2"	60	528.00 ₺	yan çıkışlı
2315	1/2"	12	1,186.00 ₺	maksijör



KOÇ DARBESİ SÖNÜMLEYİCİ

ÜRÜN KODU	ÜRÜN ÖLÇÜSÜ	KOLİ ADEDİ	FİYATI
4215	1/2"	12	1,435.00 ₺



NİSAN 2026

SU BASINÇ DÜŞÜRÜCÜ		Manometreli	
ÜRÜN KODU	ÜRÜN ÖLÇÜSÜ	KOLİ ADEDİ	FİYATI
3515	1/2"	20	1,231.00 ₺
3520	3/4"	20	1,360.00 ₺



SU BASINÇ DÜŞÜRÜCÜ

ÜRÜN KODU	ÜRÜN ÖLÇÜSÜ	KOLİ ADEDİ	FİYATI
0308	1/4"	25	1,100.00 ₺
0315	1/2"	30	1,397.00 ₺
0320	3/4"	30	1,437.00 ₺
0325	1"	10	3,588.00 ₺
0332	1 1/4"	10	4,566.00 ₺
0340	1 1/2"	10	4,662.00 ₺
0350	2"	10	5,924.00 ₺



SU BASINÇ DÜŞÜRÜCÜ		Rakorlu	
ÜRÜN KODU	ÜRÜN ÖLÇÜSÜ	KOLİ ADEDİ	FİYATI
0415	1/2"	30	1,596.00 ₺
0420	3/4"	30	1,772.00 ₺



NİSAN 2026



SU BASINÇ DÜŞÜRÜCÜ

ÜRÜN KODU	ÜRÜN ÖLÇÜSÜ	KOLİ ADEDİ	FİYATI
3315	1/2"	40	813.00 ₺
3320	3/4"	40	942.00 ₺



SU BASINÇ DÜŞÜRÜCÜ

Rakorlu

ÜRÜN KODU	ÜRÜN ÖLÇÜSÜ	KOLİ ADEDİ	FİYATI
3415	1/2"	40	1,011.00 ₺
3420	3/4"	40	1,142.00 ₺



SU BASINÇ DÜŞÜRÜCÜ

Rakorlu Ve Manometreli

ÜRÜN KODU	ÜRÜN ÖLÇÜSÜ	KOLİ ADEDİ	FİYATI
3615	1/2"	20	1,427.00 ₺
3620	3/4"	20	1,558.00 ₺



001.02.2026

AYARLANABİLİR EMNİYET VENTİLİ D/D

Bağlantı şekli

Dişi / Dişi (İçdişli)

Basınç

2 / 12 Bar

Sıcaklık

Max. 200 °C

Kullanım

Buhar Su Hava Diğer Akışkanlar

CE



Kod	DN	Ölçü	Kutu Adet	Koli Adet	FİYAT	Boy ve Ağırlık		
						L mm	H mm	Gr.
S101	15	1/2"	10	60	908,00 ₺	120	50	310
S102	20	3/4"	6	36	1.366,00 ₺	150	55	500
S103	25	1"	5	30	1.737,00 ₺	155	70	660
S104	32	1 1/4"	4	24	3.478,00 ₺	175	73	1.050
S105	40	1 1/2"	3	18	4.709,00 ₺	180	75	1000
S106	50	2"	2	12	7.355,00 ₺	205	93	1700
S107	65	2 1/2"	1	6	14.299,00 ₺	230	114	2700
S108	80	3"	1	6	19.076,00 ₺	245	128	3300
S353	25	1"	5	30	4.939,00 ₺	Özel 25 bar		

AYARLANABİLİR EMNİYET VENTİLİ E/D

Bağlantı şekli

Erkek / Dişi (Dışdişli)

Basınç

2 / 12 Bar

Sıcaklık

Max. 200 °C

Kullanım

Buhar Su Hava Diğer Akışkanlar

CE



Kod	DN	Ölçü	Kutu Adet	Koli Adet	FİYAT	Boy ve Ağırlık		
						L mm	H mm	Gr.
S311	15	1/2"	10	60	908,00 ₺	120	50	330
S312	20	3/4"	6	36	1.366,00 ₺	150	55	510
S313	25	1"	5	30	1.737,00 ₺	155	70	700
S314	32	1 1/4"	4	24	3.478,00 ₺	175	73	1.120
S315	40	1 1/2"	3	18	4.709,00 ₺	180	75	1060
S316	50	2"	2	12	7.355,00 ₺	205	93	1730

001.02.2026

SABİT AYARLI EMNİYET VENTİLİ 1/2"



Kod	DN	Ölçü	Kutu / Koli Ad.	Bar	FİYAT	Boy ve Ağırlık		
						L mm	H mm	Gr.
S133	15 E/D	1/2"	20 / 120	3	229,00 ₺	67	30	90
S134	15 E/D	1/2"	20 / 120	4	240,00 ₺	67	30	90
S135	15 E/D	1/2"	20 / 120	5	240,00 ₺	67	30	90
S136	15 E/D	1/2"	20 / 120	6	240,00 ₺	67	30	90
S138	15 E/D	1/2"	20 / 120	8	251,00 ₺	67	30	90
S139	15 E/D	1/2"	20 / 120	9	281,00 ₺	67	30	90
S140	15 E/D	1/2"	20 / 120	10	281,00 ₺	67	30	90

SABİT AYARLI EMNİYET VENTİLİ 3/4"



Kod	DN	Ölçü	Kutu / Koli Ad.	Bar	FİYAT	Boy ve Ağırlık		
						L mm	H mm	Gr.
S233	20 E/D	3/4"	10 / 0	3	360,00 ₺	86	45	185
S234	20 E/D	3/4"	10 / 0	4	360,00 ₺	86	45	185
S235	20 E/D	3/4"	10 / 0	5	371,00 ₺	86	45	185
S236	20 E/D	3/4"	10 / 0	6	371,00 ₺	86	45	185
S238	20 E/D	3/4"	10 / 0	8	382,00 ₺	86	45	185
S239	20 E/D	3/4"	10 / 0	9	397,00 ₺	86	45	185
S240	20 E/D	3/4"	10 / 0	10	397,00 ₺	86	45	185

SABİT AYARLI EMNİYET VENTİLİ 1"



Kod	DN	Ölçü	Kutu / Koli Ad.	Bar	FİYAT	Boy ve Ağırlık		
						L mm	H mm	Gr.
S333	25 E/D	1"	10 / 60	3	602,00 ₺	92	50	245
S334	25 E/D	1"	10 / 60	4	602,00 ₺	92	50	245
S335	25 E/D	1"	10 / 60	5	620,00 ₺	92	50	245
S336	25 E/D	1"	10 / 60	6	638,00 ₺	92	50	245
S338	25 E/D	1"	10 / 60	8	657,00 ₺	92	50	250
S339	25 E/D	1"	10 / 60	9	674,00 ₺	92	50	250
S340	25 E/D	1"	10 / 0	10	674,00 ₺	92	50	250

001.02.2026

SABİT AYARLI EMNİYET VENTİLİ 1 1/4"



Kod	DN	Ölçü	Kutu / Koli Ad.	Bar	FİYAT	Boy ve Ağırlık		
						L mm	H mm	Gr.
S433	32/40D/D	1 1/4"	1 / 5	3	1.636,00 ₺	118	65	640
S434	32/40D/D	1 1/4"	1 / 5	4	1.636,00 ₺	118	65	640
S435	32/40D/D	1 1/4"	1 / 5	5	1.636,00 ₺	118	65	640
S436	32/40D/D	1 1/4"	1 / 5	6	1.636,00 ₺	118	65	640
S438	32/40D/D	1 1/4"	1 / 5	8	1.718,00 ₺	118	65	640
S439	32/40D/D	1 1/4"	1 / 5	9	1.718,00 ₺	118	65	640
S440	32/40D/D	1 1/4"	1 / 5	10	1.718,00 ₺	118	65	640

BASINÇ DÜŞÜRÜCÜ



Kod	DN	Ölçü	Kutu / Koli	Çıkış Bar	FİYAT	Boy ve Ağırlık		
						L mm	H mm	Gr.
R131	15	1/2"	8 / 48	1--6	666,00 ₺	103	53	320
R132	20	3/4"	8 / 48	1--6	707,00 ₺	103	53	330
R133	25	1"	1 / 20	1--7	1.794,00 ₺	165	73	890
R134	32	1 1/4"	1 / 15	1--7	2.078,00 ₺	170	75	1040
R135	40	1 1/2"	1 / 15	1--7	2.197,00 ₺	170	77	1060
R136	50	2"	1 / 12	1--7	3.413,00 ₺	180	86	1520
R137	65	2 1/2"	1 / 6	1--7	8.912,00 ₺	240	105	3100
R138	80	3"	1 / 6	1--7	12.308,00 ₺	255	105	3350

BASINÇ DÜŞÜRÜCÜ (MANOMETRELİ)



Kod	DN	Ölçü	Kutu / Koli	Çıkış Bar	FİYAT	Boy ve Ağırlık		
						L mm	H mm	Gr.
R141	15	1/2"	8 / 48	1--6	809,00 ₺	163	53	395
R142	20	3/4"	8 / 48	1--6	849,00 ₺	163	53	405
R143	25	1"	1 / 20	1--7	1.937,00 ₺	215	73	965
R144	32	1 1/4"	1 / 15	1--7	2.220,00 ₺	220	75	1.115
R145	40	1 1/2"	1 / 15	1--7	2.339,00 ₺	240	77	1.135
R146	50	2"	1 / 12	1--7	3.555,00 ₺	240	86	1.595
R147	65	2 1/2"	1 / 6	1--7	9.055,00 ₺	300	105	3.175
R148	80	3"	1 / 6	1--7	12.451,00 ₺	315	105	3.425

Yeni Ürün

01.02.2026

1/2 UZATMA 25mm



KOD	ÖLÇÜ	KOLİ AD.	FİYAT
4962	1 cm	1000	54,00
4963	1,5 cm	1000	65,00
4964	2 cm	600	77,00
4965	2,5 cm	600	88,00
4966	3 cm	500	100,00
4967	4 cm	400	121,00
4968	5 cm	300	141,00

1/2 UZATMA 26mm



KOD	ÖLÇÜ	KOLİ AD.	FİYAT
4969	1 cm	1000	65,00
4970	1,5 cm	1000	76,00
4971	2 cm	600	88,00
4972	2,5 cm	600	100,00
4973	3 cm	500	114,00
4974	4 cm	400	147,00
4975	5 cm	300	169,00

3/4 UZATMA



KOD	ÖLÇÜ	KOLİ AD.	FİYAT
4976	1 cm	1000	83,00
4977	1,5 cm	1000	96,00
4978	2 cm	600	110,00
4979	2,5 cm	600	124,00
4980	3 cm	500	137,00

KROM UZATMALAR



KOD	ÖLÇÜ	FİYAT
4989	1/2 DELİKLİ	185,00
4990	3/4 DELİKLİ	233,00
4995	3/4 DELİKSİZ	219,00
4986	BAS UZATMASI	93,00
4987	ÇAMAŞIR ÇATALI	212,00

SARI NİPEL



KOD	ÖLÇÜ	KOLİ AD.	FİYAT
4160	1/8	-	38,00
4161	1/4	-	45,00
4162	3/8	-	44,00
4163	1/2	-	52,00
4164	3/4	-	81,00
4165	1	-	127,00
4166	1 1/4	-	253,00
4167	1 1/2	-	298,00
4168	2	-	506,00
6624	2 1/2	-	2.100,00
6625	3"	-	3.900,00

SARI ORANTILI NİPEL

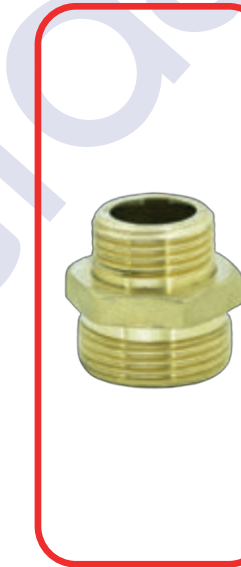

KOD	ÖLÇÜ	FİYAT
4170	1/4 x 1/8	52,00
4171	3/8 x 1/8	63,00
4172	3/8 x 1/4	63,00
4173	1/2 x 1/8	55,00
4174	1/2 x 1/4	54,00
4175	1/2 x 3/8	51,00
4176	3/4 x 1/2	78,00
4177	1" x 1/2	122,00
4178	1" x 3/4	127,00
4180	1 1/4 x 1"	327,00
4181	1 1/2 x 1"	485,00

01.02.2026

PRİNÇ EK PARÇALAR-2

ÇUBUK HORTUM REKORLARI (AĞIR TİP)

KOD	ÖLÇÜ	FİYAT
	1/8 6-8-10 mm	52,00
	1/8 12 mm	64,00
	1/4 6-8-10-12 mm	64,00
	3/8 6 mm	72,00
	3/8 8-10-12 mm	81,00
	3/8 14-16 mm	87,00
	1/2 6-8-10-12 mm	79,00
	1/2 14-16 mm	85,00
	1/2 20 mm	102,00
	3/4 8-10-12 mm	104,00
	3/4 14-16 mm	112,00
	3/4 20 mm	172,00
	3/4 27 mm	208,00
	1" 20 mm	235,00
	1" 27 mm	227,00
	1" 33 mm	345,00
	1 1/4 33 mm	615,00
	1 1/4 40 mm	645,00
	1 1/2 33 mm	
	1 1/2 40 mm	690,00
	2" 50 mm	752,00

SARI REDÜKSİYONLAR

KOD	ÖLÇÜ	FİYAT
4100	1/4 x 1/8	38,00
4101	3/8 x 1/8	50,00
4102	3/8 x 1/4	52,00
4103	1/2 x 1/8	60,00
4104	1/2 x 1/4	52,00
4105	1/2 x 3/8	51,00
4106	3/4 x 1/8	107,00
4107	3/4 x 1/4	107,00
4108	3/4 x 3/8	90,00
4109	3/4 x 1/2	69,00
4111	1" x 1/4	156,00
4112	1" x 3/8	156,00
4113	1" x 1/2	112,00
4114	1" x 3/4	112,00
4115	1 1/4 x 1/2	283,00
4116	1 1/4 x 3/4	283,00
4117	1 1/4 x 1"	201,00
4118	1 1/2 x 1/2	364,00
		364,00
4120	1 1/2 x 1"	364,00
4121	1 1/2 x 1 1/4	298,00
4124	2" x 1"	624,00
4125	2" x 1 1/4	624,00
4126	2" x 1 1/2	624,00

SARI HORTUM REKORU

KOD	ÖLÇÜ	KOLİ AD.	FİYAT
4131	1/2	150	82,00
4132	3/4	100	89,00
4133	1	60	149,00
4134	1 1/4	50	216,00
4135	1 1/2	35	241,00
4136	2	25	500,00
4137	2 1/2	12	825,00
4138	3	6	1.105,00
4139	4	4	1.857,00

SARI DİŞİ HORTUM REKORU

KOD	ÖLÇÜ	FİYAT
	1/4 6-8-10-12 mm	85,00
	3/8 6-8-10-12 mm	100,00
	1/2 8-10 mm	130,00
	1/2 12-16-20 mm	135,00
	3/4 8-10-12 mm	315,00
	3/4 16-20 mm	315,00

**İŞİMİZİN
HER ALANINDA
ÜRETMENİN VE
DEĞER
YARATMANIN
GÜCÜNE
İNANIYORUZ.**

S ^{1986'dan beri} **serdaroglu**®



YANGIN EKİPMANLARI

FIYAT LİSTESİ



1986'dan beri

serdaroglu[®]

TESİSAT TEKNİK MALZEME SAN. TİC. A.Ş.



01.02.2026









USD (\$)

SPRINKLER







			1/2" (68°C)	1/2" (79°C)	1/2" (93°C)	1/2" (141°C)	3/4" (68°C)	3/4" (79°C)	3/4" (93°C)	3/4" (141°C)
UNIVAL, Upright Sprinkler, K:5,6 Standart Tepkimeli, Pirinç			10,18	11,74	11,74	11,74	-	-	-	-
UNIVAL, Upright Sprinkler, K:5,6 Hızlı Tepkimeli, Pirinç			11,20	12,26	12,26	12,26	-	-	-	-
UNIVAL, Pendent Sprinkler, K:5,6 Standart Tepkimeli, Beyaz			11,22	12,78	12,78	12,78	-	-	-	-
UNIVAL, Pendent Sprinkler, K:5,6 Hızlı Tepkimeli, Beyaz			12,00	13,57	13,57	13,57	-	-	-	-
UNIVAL, Sidewall Sprinkler, K:5,6 Standart Tepkimeli, Beyaz			13,66	15,45	15,45	15,45	-	-	-	-
UNIVAL, Sidewall Sprinkler, K:5,6 Hızlı Tepkimeli, Beyaz			14,52	16,40	16,40	16,40	-	-	-	-
UNIVAL, Upright Sprinkler, K:8,0 Standart Tepkimeli, Pirinç			-	-	-	-	17,74	18,97	18,97	18,97
UNIVAL, Upright Sprinkler, K:8,0 Hızlı Tepkimeli, Pirinç			-	-	-	-	18,73	20,00	20,00	20,00
UNIVAL, Pendent Sprinkler, K:8,0 Standart Tepkimeli, Beyaz			-	-	-	-	19,22	20,06	20,06	20,06
UNIVAL, Pendent Sprinkler, K:8,0 Hızlı Tepkimeli, Beyaz			-	-	-	-	20,20	21,60	21,60	21,60
UNIVAL, Gizli Tavan Tip Sprinkler, K:5,6 Hızlı Tepkimeli + BEYAZ KAPA			38,00	-	-	-	-	-	-	-
UNIVAL İki Parçalı Rozet, Beyaz			1,50	-	-	-	-	2,34	-	-
UNIVAL Kromajlı Sprinkler Kafesi			9,43	-	-	-	-	-	-	-
UNIVAL Sprinkler Takma Anahtarı			130,00	-	-	-	-	-	-	-
UNIVAL Gizli Tip Sprinkler Takma Anahtarı			140,00	-	-	-	-	-	-	-

01.02.2026

SPRINKLER					USD (\$)	
		3/4" (74°C)	1" (74°C)	-	-	-
UNIVAL, ESFR -363/P Pendent K25.2		-	56.12	-	-	-
UNIVAL, ESFR -363/U Upright K25.2		-	56.12	-	-	-
UNIVAL, ESFR -242/P Pendent K16.8		43.61	-	-	-	-
UNIVAL, ESFR -242/U UPRIGHT K16.8		43.61	-	-	-	-
UNIVAL, CMSAT -Z161 Upright K11.2		25.90	-	-	-	-

ALARM VANASI							USD (\$)	
			DN 50	DN 65	DN 80	DN 100	DN 150	DN 200
UNIVAL Islak Alarm Vanası, Flanşlı, 300 psi			-	-	-	2.868,77	3.164,03	3.908,31
UNIVAL Baskın (Deluge) Alarm Vanası, Flanşlı, 175 psi			5.500,00	5.900,00	6.250,00	6.600,00	7.650,00	9.850,00
UNIVAL Kuru Alarm Vanası, Flanşlı, 300 psi			-	-	-	4.729,88	5.912,90	9.472,93
UNIVAL Ön Tepkimeli (Pre-Action) Alarm Vanası, Flanşlı, 300 psi			6.082,44	6.186,21	6.725,82	7.331,59	7.964,71	-

01.02.2026





YANGIN SÖNDÜRME SİSTEMİ VANALARI			USD (\$)								
			DN 50	DN 65	DN 80	DN 100	DN 125	DN 150	DN 200	DN 250	DN 300
GIACOMINI Basınç Düşürücü Vana, Sfero Döküm, Flanşlı, 300 psi (UPRV-0301)	CE		864,00	929,20	1.148,85	1.363,90	1.725,00	2.570,00	3.819,15	-	-
GIACOMINI Relief Vana, Sfero Döküm, Flanşlı, 300 psi (URLV-0301)	CE		828,00	929,20	1.276,50	1.363,90	1.725,00	2.587,50	4.243,50	-	-
GIACOMINI Flatörlü Vana, Sfero Döküm, Flanşlı, PN16 (UFKV-0301)	CE		535,44	614,56	892,40	962,32	1.251,20	2.064,48	3.170,32	-	-
WEFLO Basınç Düşürücü Vana, Flanşlı, 300 psi	FM		-	-	-	3.802,47	-	5.972,00	9.418,35	-	-
WEFLO Relief Vana, Flanşlı, 300 psi	FM		-	-	-	3.802,47	-	5.972,00	9.114,75	-	-
UNIVAL İzlenebilir Kelebek Vana Wafer, 300 psi	UL LISTED FM		-	306,90	327,86	357,17	-	468,78	725,99	1.542,63	2.022,55
UNIVAL İzlenebilir Kelebek Vana Yivli, 300 psi	UL LISTED FM		332,18	341,22	360,78	402,68	-	560,39	794,96	1.477,28	-
UNIVAL Çek Vana Yivli, 300 psi	UL LISTED FM		231,70	254,40	295,44	345,80	-	385,48	-	-	-
UNIVAL Çift Klapeli Çek Vana, 300 psi	UL LISTED FM		145,80	190,49	249,73	476,82	-	868,97	1.336,99	2.419,65	-
MECH OS&Y Sürgülü Vana, Flanşlı PN16	UL LISTED FM		-	396,18	435,29	465,32	-	901,34	1.189,03	1.677,85	-
WEFLO OS&Y Sürgülü Vana, Flanşlı 300 psi	UL LISTED FM		-	441,01	654,91	696,12	-	1.000,92	1.741,77	2.531,15	3.948,12
NRS Sürgülü Vana, 300 psi	UL LISTED FM		-	-	489,96	626,10	-	912,49	1.524,69	2.393,19	3.273,53
WEFLO Dikey Post Indicator	UL LISTED FM		-	1.302,00	-	-	-	-	-	-	-
WEFLO Duvar Post Indicator	UL LISTED FM		-	2.557,68	-	-	-	-	-	-	-
Akış Ölçer, Yivli	FM		-	-	1.814,71	2.376,19	-	2.501,25	2.876,44	3.235,29	-

İZLENEBİLİR KELEBEK VANA		UL LISTED FM	USD (\$)			
			1"	1 1/4"	1 1/2"	2"
GLOBAL SAFETY İzlenebilir Kelebek Vana, Bronz Dişli, 175 psi			313,95	336,84	366,28	465,46

01.02.2026

ANAHTARLAR		USD (\$)						
		DN 50	DN 65	DN 80	DN 100	DN 125	DN 150	DN 200
UNIVAL UVFS Akış Anahtarı		181,16	181,16	181,16	181,16	181,16	181,16	210,38
UNIVAL UVOSY-2 İzleme Anahtarı		232.04	-	-	-	-	-	-
WEFLO WPS 10-1 Basınç Anahtarı		182.95	-	-	-	-	-	-
WEFLO WPS 40-1 Basınç Anahtarı		158.06	-	-	-	-	-	-

YANGIN HİDRANTI		USD (\$)
		DN 150
WEFLO Yer Üstü Yangın Hidrantı 2025 mm Burry depth 5'-0" – (UL & FM) (F-0733)		8.470,00
WEFLO Yer Üstü Yangın Hidrantı 2025 mm Burry depth 4'-0" (UL & FM) (F-0733)		8.410,00
WEFLO Yer Üstü Yangın Hidrant Ökçesi 1116 mm (F-0733)		1.200,00

YANGIN HİDRANTI		TL		
		DN 100	DN 125 - DN 300	DN 350 - DN 400
UNIVAL Yer Üstü Yangın Hidrantı (FRH-0101) (1700 mm)		69.304,87	-	-
Yangın Hidrant Anahtarı (FRH-0101)		1.840,00	-	-
Hidrant Dirseği (FRH-0101)		7.137,42	-	-
Buşakle Takımı (Huni+Tij+ Kazan)		20.020,00	23.140,00	30.160,00

01.02.2026

GIACOMINI YANGIN SÖNDÜRME SİSTEMİ VANALARI		UL LISTED FM EURO (€)									
		1/2"	3/4"	1"	1 1/4"	1 1/2"	2"	2 1/2"	3"	4"	
Otomatik Damlatma Vanası (A58)		29.49	42.79	-	-	-	-	-	-	-	
Storz Kaplin ve Kapak		-	-	-	-	-	-	77,00	-	-	
Köşe Hortum Vanası (A55)		-	-	-	-	170,99	-	284,98	-	-	
Köşe Hortum Vanası (A56E)		-	-	-	-	170,99	-	233,74	-	-	
Basınç Düşürücü Tertibatlı Köşe Hortum Vanası (A155)		-	-	-	-	265,01	-	456,72	-	-	
Basınç Düşürücü Tertibatlı Köşe Hortum Vanası (A156)		-	-	-	-	265,01	-	456,72	-	-	
Sürgülü Vana (A53G)		-	-	-	-	-	-	436,05	-	-	
Basınç Düşürücü, Köşe Tip (A201)		-	-	-	-	-	-	1.682,09	-	-	
Basınç Düşürücü, Düz Tip (A202)		-	-	-	-	-	-	1.651,52	-	-	
Basınç Düşürücü, Düz Tip (A203 - A204)		-	-	-	-	-	-	1.651,52	-	-	
Test ve Drenaj Vanası 1/2" Orifisli (A61 Dişli)		-	-	123,00	123,00	-	237,67	-	-	-	
Test ve Drenaj Vanası (A61 Dişli) 3/8" - 7/16" - 17/32" - 5/8" 3/4" - 15/16" - 15/65" - 19/64"		-	-	162,86	186,49	-	275,00	-	-	-	

01.02.2026

GIACOMINI YANGIN SÖNDÜRME SİSTEMİ VANALARI		UL LISTED		FM		EURO (€)	
		4"	4" * 2 1/2"	4" * 3"	6" * 2 1/2"		
İtfaiye Bağlantı Ağızı, Düz/Tek Klapeli (A95)		-	315,12	-	-	-	-
İtfaiye Bağlantı Ağızı, 90°/Tek Klapeli (A96)		-	343,53	-	-	-	-
İtfaiye Bağlantı Ağızı, 90°/Düz/Çift Klapeli (A105)		-	705,31	914,78	671,67	-	-
İtfaiye Bağlantı Ağızı, 90°/Çift Klapeli (A106)		-	795,08	-	-	-	-
Çatı İtfaiye Bağlantı Ağızı, Düz/Çatı Tipi (A97)		-	-	-	-	520,00	-
Çek Vana (Dişli) (A140)		554,40	-	-	-	-	-
Çek Vana (Yivli) (A140)		462,53	-	-	-	-	-

02.02.2026

SPRINKLER (½")

Pendent (Sarkık) Sprinkler

Standart Tepkimeli
K5.6 (80) ½" NPT



Sıcaklık	Beyaz	Kromajlı	Pirinç
57 °C	\$ 6,44	\$ 8,15	\$ 6,24
68 °C	\$ 6,31	\$ 8,02	\$ 6,10
79 °C	\$ 6,44	\$ 8,15	\$ 6,24
93 °C	\$ 6,44	\$ 8,15	\$ 6,24
141 °C	\$ 6,55	\$ 8,26	\$ 6,34

*Fiyatlar USD'dir, KDV dahil değildir.

*Siparişler 100 adet ve katları şeklinde olmalıdır.



Pendent (Sarkık) Sprinkler

Hızlı Tepkimeli
K5.6 (80) ½" NPT



Sıcaklık	Beyaz	Kromajlı	Pirinç
57 °C	\$ 7,55	\$ 9,27	\$ 7,35
68 °C	\$ 7,55	\$ 9,27	\$ 7,35
79 °C	\$ 7,55	\$ 9,27	\$ 7,35
93 °C	\$ 7,55	\$ 9,27	\$ 7,35
141 °C	\$ 7,77	\$ 9,48	\$ 7,56

*Fiyatlar USD'dir, KDV dahil değildir.

*Siparişler 100 adet ve katları şeklinde olmalıdır.



Upright (Yukarı) Sprinkler

Standart Tepkimeli
K5.6 (80) ½" NPT



Sıcaklık	Pirinç	Kromajlı
57 °C	\$ 6,33	\$ 8,25
68 °C	\$ 6,20	\$ 8,11
79 °C	\$ 6,33	\$ 8,25
93 °C	\$ 6,33	\$ 8,25
141 °C	\$ 6,44	\$ 8,35

*Fiyatlar USD'dir, KDV dahil değildir.

*Siparişler 100 adet ve katları şeklinde olmalıdır.



Upright (Yukarı) Sprinkler

Hızlı Tepkimeli
K5.6 (80) ½" NPT



Sıcaklık	Pirinç	Kromajlı
57 °C	\$ 7,44	\$ 9,36
68 °C	\$ 7,44	\$ 9,36
79 °C	\$ 7,44	\$ 9,36
93 °C	\$ 7,44	\$ 9,36
141 °C	\$ 7,66	\$ 9,57

*Fiyatlar USD'dir, KDV dahil değildir.

*Siparişler 100 adet ve katları şeklinde olmalıdır.



Sidewall (Duvar) Sprinkler

Standart Tepkimeli
K5.6 (80) ½" NPT



Sıcaklık	Beyaz	Kromajlı	Pirinç
57 °C	\$ 6,50	\$ 8,20	\$ 6,28
68 °C	\$ 6,36	\$ 8,06	\$ 6,15
79 °C	\$ 6,50	\$ 8,20	\$ 6,28
93 °C	\$ 6,50	\$ 8,20	\$ 6,28
141 °C	\$ 6,60	\$ 8,30	\$ 6,39

*Fiyatlar USD'dir, KDV dahil değildir.

*Siparişler 100 adet ve katları şeklinde olmalıdır.



Sidewall (Duvar) Sprinkler

Hızlı Tepkimeli
K5.6 (80) ½" NPT



Sıcaklık	Beyaz	Kromajlı	Pirinç
57 °C	\$ 7,61	\$ 9,31	\$ 7,39
68 °C	\$ 7,61	\$ 9,31	\$ 7,39
79 °C	\$ 7,61	\$ 9,31	\$ 7,39
93 °C	\$ 7,61	\$ 9,31	\$ 7,39
141 °C	\$ 7,82	\$ 9,52	\$ 7,61

*Fiyatlar USD'dir, KDV dahil değildir.

*Siparişler 100 adet ve katları şeklinde olmalıdır.



02.02.2026

SPRINKLER (¾") Pendent

(Sarkık) Sprinkler

Standart Tepkimeli
K8.0 (115) ¾" NPT



Sıcaklık	Beyaz	Kromajlı	Pirinç
57 °C	\$ 11,44	\$ 13,29	\$ 11,23
68 °C	\$ 11,30	\$ 13,15	\$ 11,08
79 °C	\$ 11,44	\$ 13,29	\$ 11,23
93 °C	\$ 11,44	\$ 13,29	\$ 11,23
141 °C	\$ 11,56	\$ 13,40	\$ 11,34

*Fiyatlar USD'dir, KDV dahil değildir.

*Siparişler 100 adet ve katları şeklinde olmalıdır.



Pendent (Sarkık) Sprinkler

Hızlı Tepkimeli
K8.0 (115) ¾" NPT



Sıcaklık	Beyaz	Kromajlı	Pirinç
57 °C	\$ 12,64	\$ 14,49	\$ 12,42
68 °C	\$ 12,64	\$ 14,49	\$ 12,42
79 °C	\$ 12,64	\$ 14,49	\$ 12,42
93 °C	\$ 12,64	\$ 14,49	\$ 12,42
141 °C	\$ 12,87	\$ 14,72	\$ 12,65

*Fiyatlar USD'dir, KDV dahil değildir.

*Siparişler 100 adet ve katları şeklinde olmalıdır.



Upright (Yukarı) Sprinkler

Standart Tepkimeli
K8.0 (115) ¾" NPT



Sıcaklık	Pirinç	Kromajlı
57 °C	\$ 11,33	\$ 13,39
68 °C	\$ 11,18	\$ 13,25
79 °C	\$ 11,33	\$ 13,39
93 °C	\$ 11,33	\$ 13,39
141 °C	\$ 11,44	\$ 13,50

*Fiyatlar USD'dir, KDV dahil değildir.

*Siparişler 100 adet ve katları şeklinde olmalıdır.



Upright (Yukarı) Sprinkler

Hızlı Tepkimeli
K8.0 (115) ¾" NPT



Sıcaklık	Pirinç	Kromajlı
57 °C	\$ 12,53	\$ 14,59
68 °C	\$ 12,53	\$ 14,59
79 °C	\$ 12,53	\$ 14,59
93 °C	\$ 12,53	\$ 14,59
141 °C	\$ 12,75	\$ 14,82

*Fiyatlar USD'dir, KDV dahil değildir.

*Siparişler 100 adet ve katları şeklinde olmalıdır.



Sidewall (Duvar) Sprinkler

Standart Tepkimeli
K8.0 (115) ¾" NPT



Sıcaklık	Beyaz	Kromajlı	Pirinç
57 °C	\$11,51	\$13,34	\$11,27
68 °C	\$11,36	\$13,19	\$11,13
79 °C	\$11,51	\$13,34	\$11,27
93 °C	\$11,51	\$13,34	\$11,27
141 °C	\$11,62	\$13,45	\$11,39

*Fiyatlar USD'dir, KDV dahil değildir.

*Siparişler 100 adet ve katları şeklinde olmalıdır.



Sidewall (Duvar) Sprinkler

Hızlı Tepkimeli
K8.0 (115) ¾" NPT



Sıcaklık	Beyaz	Kromajlı	Pirinç
57 °C	\$12,71	\$14,54	\$12,47
68 °C	\$12,71	\$14,54	\$12,47
79 °C	\$12,71	\$14,54	\$12,47
93 °C	\$12,71	\$14,54	\$12,47
141 °C	\$12,93	\$14,76	\$12,70

*Fiyatlar USD'dir, KDV dahil değildir.

*Siparişler 100 adet ve katları şeklinde olmalıdır.



Sprinkler Rozeti

Tek / Çift Parçalı

Çap	Beyaz	Kromajlı
½"	\$ 1,39	\$ 1,91
¾"	\$ 1,59	\$ 2,11

*Fiyatlar USD'dir, KDV dahil değildir.



Koruma Kafesi

Çap	Kromajlı
½"	\$ 12,07
¾"	\$ 12,07

*Fiyatlar USD'dir, KDV dahil değildir.



02.02.2026

ARMAŞ |

JAYLI

Model	Çap	Fiyat USD
FCV-02	Ø65-2½"	\$ 1.360
FCV-03	Ø80-3"	\$ 1.372
FCV-04	Ø100-4"	\$ 1.658
FCV-06	Ø150-6"	\$ 2.181
FCV-08	Ø200-8"	\$ 2.796
UL Onaylı Basınç Anahtarı		\$ 440

*Basınç anahtarı fiyata dahil değildir.

*Fiyatlar USD'dir ve KDV dahil değildir.

Gövde : Sfero Döküm-GGG50
Bağlantı Şekli : Flanşlı
Maks. Çalışma Sıcaklığı : 80 °C
Dahil olan parçalar : Islak Alarm Vana Gövdesi, Geciktirme Haznesi, Kit, Su Motoru Alarm Gongu
 *4", 6" ve 8" UL onaylıdır.



ARMEX ISLAK ALARM VANASI

Model	Çap	Fiyat USD
AX-FCV-02	Ø65-2½"	\$ 1.026
AX-FCV-03	Ø80-3"	\$ 1.018
AX-FCV-04	Ø100-4"	\$ 1.045
AX-FCV-06	Ø150-6"	\$ 1.342
AX-FCV-08	Ø200-8"	\$ 1.677

*Fiyatlar USD'dir ve KDV dahil değildir.

Gövde : Sfero Döküm-GGG50
Bağlantı Şekli : Flanşlı
Maks. Çalışma Sıcaklığı : 80 °C
Dahil olan parçalar : Islak Alarm Vana Gövdesi, Geciktirme Haznesi, Kit, Su Motoru Alarm Gongu, Basınç Anahtarı, Ambalaj



ARMAŞ KURU ALARM VANASI

Kod	Çap	Fiyat (USD)
DCV-100	Ø100-4"	\$ 2.787
DCV-150	Ø150-6"	\$ 3.552
DCV-200	Ø200-8"	Yakında

**Fiyatlar USD'dir ve KDV dahil değildir.

Gövde : Sfero Döküm (GGG40)
Bağlantı Şekli : Flanşlı
Maks. Çalışma Sıcaklığı : 80 °C
Dahil Olan Parçalar : Kuru Alarm Vanası Gövdesi, Basınç Anahtarı, Alarm Gongu, Hava Tedarik Ekipmanı, Hızlandırıcı



02.02.2026

ARMAS İZLENEBİLİR KELEBEK VANA

TSEK CE

Çap	Fiyat-USD
Ø50-2"	\$ 156
Ø65-2½"	\$ 165
Ø80-3"	\$ 174
Ø100-4"	\$ 211
Ø125-5"	\$ 301
Ø150-6"	\$ 338
Ø200-8"	\$ 460
Ø250-10"	YAKINDA
Ø300-12"	



*Fiyatlar USD'dir ve KDV dahil değildir.

Bağlantı Şekli : Wafer
Maks. Çalışma Basıncı : 300 psi-21 bar
Maks. Çalışma Sıcaklığı : 80 °C
Gövde : Sfero Döküm-GGG50
Klape : EPDM Kaplı Sfero Döküm
Mil : Paslanmaz Çelik
İzleme Anahtarı : Epoxy Kaplı Sfero Döküm

ARMAS OS&Y YÜKSELEN MİLLİ SÜRGÜLÜ VANA

CE TSE

Çap	Fiyat-USD
Ø50-2"	\$ 399
Ø65-2½"	\$ 451
Ø80-3"	\$ 491
Ø100-4"	\$ 540
Ø125-5"	\$ 645
Ø150-6"	\$ 782
Ø200-8"	\$ 1.106



*Fiyatlar USD'dir ve KDV dahil değildir.

Bağlantı Şekli : Flanşlı
Maks. Çalışma Basıncı : 300 psi-21 bar
Maks. Çalışma Sıcaklığı : 80 °C
Gövde : Sfero Döküm-GGG50
Klape : EPDM Kaplı Sfero Döküm
Mil : Paslanmaz Çelik

İTFAİYE BAĞLANTI AĞZI

Çap	Fiyat-USD
4" x 2½"	\$ 156

Bağlantı Şekli : Kurt ağız - Dişli
Maks. Çalışma Basıncı : 175 psi - 12 bar
Gövde : Sfero Döküm (GGG50)

TSEK



ARMAS NRS YÜKSELMİYEN MİLLİ SÜRGÜLÜ VANA-PRO

PRO

CE TSE

Çap	Fiyat-USD
Ø50-2"	YAKINDA
Ø65-2½"	
Ø80-3"	
Ø100-4"	
Ø125-5"	
Ø150-6"	
Ø200-8"	



*Fiyatlar USD'dir ve KDV dahil değildir.

Bağlantı Şekli : Flanşlı
Maks. Çalışma Basıncı : 300 psi-21 bar
Maks. Çalışma Sıcaklığı : 80 °C
Gövde : Sfero Döküm-GGG50
Klape : EPDM Kaplı Sfero Döküm
Mil : Paslanmaz Çelik

ARMAS OS&Y YÜKSELEN MİLLİ SÜRGÜLÜ VANA-PRO

PRO

CE TSE

Çap	Fiyat-USD
Ø50-2"	YAKINDA
Ø65-2½"	
Ø80-3"	
Ø100-4"	
Ø125-5"	
Ø150-6"	
Ø200-8"	



*Fiyatlar USD'dir ve KDV dahil değildir.

Bağlantı Şekli : Flanşlı
Maks. Çalışma Basıncı : 300 psi-21 bar
Maks. Çalışma Sıcaklığı : 80 °C
Gövde : Sfero Döküm-GGG50
Klape : EPDM Kaplı Sfero Döküm
Mil : Paslanmaz Çelik

02.02.2026

ARMAS AKIŞ ANAHTARI (FLOW SWITCH)



Kod	Çap	Fiyat-USD
FS-050	Ø50-2"	\$ 115
FS-065	Ø65-2½"	\$ 115
FS-080	Ø80-3"	\$ 121
FS-100	Ø100-4"	\$ 123
FS-125	Ø125-5"	\$ 125
FS-150	Ø150-6"	\$ 133
FS-200	Ø200-8"	\$ 139

*Fiyatlar USD'dir ve KDV dahil değildir.

Anma Basıncı	: 300 psi, 21 bar
Debi Hassasiyet Aralığı	: 15-37.5 l/dk (4-10 gpm)
Kontak Değerleri	: 10(3)125/250V AC, 6A 24/30V DC
Maks. Geciktirme Süresi	: 90 saniye
Boru Standardı	: Sch 10-40

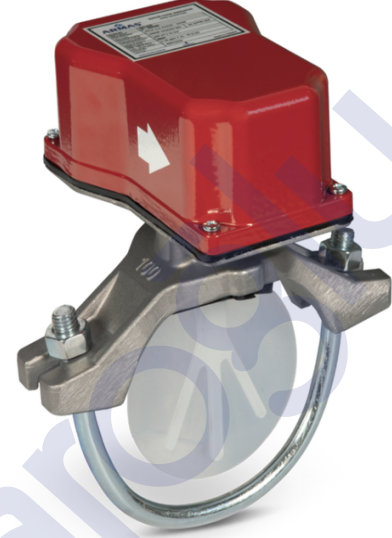

ARMAS BASINÇ ANAHTARI (PRESSURE SWITCH)

Çap	Kart Adedi	Fiyat-USD
½"	Tek	\$ 89
	Çift	\$ 120

*Fiyatlar USD'dir ve KDV dahil değildir.

*Belgelendirme çalışmalarını devam ettirmektedir.

Anma Basıncı	: 300 psi, 21 bar
Basınç Ayar Aralığı	: 4-20 psi
Elektriksel Değerler	: 125/250 VAC ~ 10.1A, 24 VDC ~ 2A
Akışkan	: Su



02.02.2026

ARMAŞ TEST VE DRENAJ VANASI-UL/FM ONAYLI



Model	Çap	Fiyat-USD
TD-UL-25	1"	\$ 125
TD-UL-32	1¼"	\$ 121
TD-UL-40	1½"	\$ 243
TD-UL-50	2"	\$ 245

*Fiyatlar USD'dir ve KDV dahil değildir.

K-Faktör	: K5.6 - K8.0
Gövde	: Pirinç (Ms58)
Küre	: Pirinç (Ms58)-Krom Kaplı
Bağlantı Şekli	: Dişli-BSP veya NPT
Maks. Çalışma Basıncı	: 300 psi-21 bar
Maks. Çalışma Sıcaklığı	: 80 °C

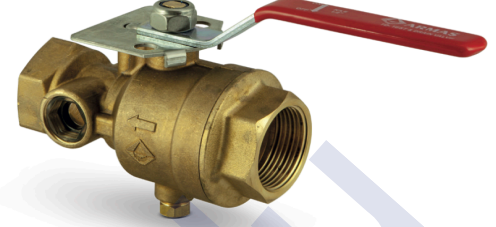

ARMEX TEST VE DRENAJ VANASI-Döküm Gövde



Model	Çap	Fiyat-USD
AX-TD-25	1"	\$ 79
AX-TD-32	1¼"	\$ 77
AX-TD-40	1½"	\$ 116
AX-TD-50	2"	\$ 113

*Fiyatlar USD'dir ve KDV dahil değildir.

K-Faktör	: K5.6 - K8.0
Gövde	: Sfero Döküm-GGG50
Küre	: Pirinç (Ms58)-Krom Kaplı
Bağlantı Şekli	: Dişli-BSP veya NPT
Maks. Çalışma Basıncı	: 300 psi-21 bar
Maks. Çalışma Sıcaklığı	: 80 °C



RELIEF (BASINÇ TAHLİYE) VANASI-UL ONAYLI



Model	Çap	Fiyat-USD
87-UL-QR-050	Ø50-2"	\$ 1.213
87-UL-QR-065	Ø65-2½"	\$ 1.247
87-UL-QR-080	Ø80-3"	\$ 1.497
87-UL-QR-100	Ø100-4"	\$ 1.731
87-UL-QR-150	Ø150-6"	\$ 2.852

*Fiyatlar USD'dir ve KDV dahil değildir.

Gövde	: Sfero Döküm-GGG50
Bağlantı Şekli	: Flanşlı-ISO veya ANSI
Maks. Çalışma Basıncı	: 240 psi-16 bar
Maks. Çalışma Sıcaklığı	: 80 °C



02.02.2026

PRE-ACTION VANA



Çift Kilitlemeli, Elektrik Kontrollü
Manuel Reset

Çap	Fiyat-USD
Ø50-2"	\$ 2.198
Ø65-2½"	\$ 2.235
Ø80-3"	\$ 2.428
Ø100-4"	\$ 2.672
Ø125-5"	\$ 3.025
Ø150-6"	\$ 4.076
Ø200-8"	\$ 5.845

*Ex proof korumalı solenoid için fiyat sorunuz.
*Fiyatlar USD'dir ve KDV dahil değildir.

Gövde	: Sfero Döküm-GGG50
Bağlantı Şekli	: Flanşlı-ISO veya ANSI
Maks. Çalışma Basıncı	: 300 psi-21 bar
Maks. Çalışma Sıcaklığı	: 80 °C
Solenoid	: 2/2 Way N.C. Solenoid 24V DC



77PA-EL-MR

PRE-ACTION VANA



Çift Kilitlemeli, Elektro-Pnömatik Kontrollü
Manuel Reset

Çap	Fiyat-USD
Ø50-2"	\$ 2.765
Ø65-2½"	\$ 2.801
Ø80-3"	\$ 2.964
Ø100-4"	\$ 3.208
Ø125-5"	\$ 3.561
Ø150-6"	\$ 4.605
Ø200-8"	\$ 6.374

*Ex proof korumalı solenoid için fiyat sorunuz.
*Fiyatlar USD'dir ve KDV dahil değildir.

Gövde	: Sfero Döküm-GGG50
Bağlantı Şekli	: Flanşlı-ISO veya ANSI
Maks. Çalışma Basıncı	: 300 psi-21 bar
Maks. Çalışma Sıcaklığı	: 80 °C
Solenoid	: 2/2 Way N.C. Solenoid 24V DC



77PA-EL-PN-MR

02.02.2026

ARMEX YERÜSTÜ YANGIN HİDRANTI

armex



Çap	Fiyat-USD	
	145 cm	175 cm
Ø80-3"	\$ 737	\$ 770
Ø100-4"	\$ 776	\$ 823

*Fiyatlar USD'dir ve KDV dahil değildir.

Standart : TS EN 14384
Gövde : Pik Döküm-GG25
Bağlantı Şekli : Flanşlı-ISO veya ANSI
Maks. Çalışma Basıncı : 240 psi-16 bar
Maks. Çalışma Sıcaklığı : 80 °C

*Hidrانت ek parçaları fiyata dahil değildir.

YANGIN HİDRANTI EK PARÇALARI

Çap	Fiyat-USD	
	N Parçası	Hidrانت Anahtarı
Ø80-3"	\$ 145	\$ 12
Ø100-4"	\$ 156	\$ 12

* Fiyatlar USD'dir ve KDV dahil değildir.



HİDROLİK YANGIN HİDRANTI

Su Alma Çıkışı	Fiyat-USD
Tek	\$ 468
Çift	\$ 1.237

*Fiyatlar USD'dir ve KDV dahil değildir.

Bağlantı Şekli : Tek Çıkışı: Dişli - 3"
Çift Çıkışı: Flanşlı - 4"
Gövde : Sfero Döküm (GGG40)
Maks. Çalışma Basıncı : 16 bar - 240 psi



Çift Çıkışlı



Tek Çıkışlı

02.02.2026

ARMAS

armex

Model AX-F, Pik Döküm (GG25), Flanşlı, 230 PSI

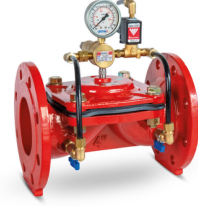

CE
TSE
EN 1074-5

ÜRÜN ADI	ÇAP KOD	2" Ø50	2½" Ø65	3" Ø80	4" Ø100	5" Ø125	6" Ø150	8" Ø200
BASIC VANA	B	\$ 111	\$ 131	\$ 217	\$ 237	\$ 300	\$ 641	\$1.112
MANUEL KONTROL VANASI	M	\$ 202	\$ 217	\$ 303	\$ 321	\$ 388	\$ 752	\$1.209
SOLENOID KONTROL VANASI (SOLENOID 24V AC)	EL	\$ 374	\$ 389	\$ 475	\$ 493	\$ 571	\$ 934	\$1.631
BASINÇ DÜŞÜRÜCÜ VANA	PR	\$ 371	\$ 387	\$ 472	\$ 490	\$ 569	\$ 911	\$1.404
SOLENOID KONTROLLÜ BASINÇ DÜŞÜRÜCÜ VANA	PREL	\$ 534	\$ 549	\$ 635	\$ 653	\$ 742	\$1.085	\$1.555
BASINÇ SABİTLEME VANASI	PS	\$ 385	\$ 400	\$ 486	\$ 504	\$ 583	\$ 926	\$1.395
BASINÇ DÜŞÜRÜCÜ VE BASINÇ SABİTLEME VANASI	PRPS	\$ 561	\$ 577	\$ 662	\$ 680	\$ 771	\$1.112	\$1.585
FLATÖRLÜ SEVİYE KONTROL VANASI	FL	\$ 314	\$ 329	\$ 415	\$ 433	\$ 507	\$ 847	\$1.320
ELEKTRİK FLATÖRLÜ SEVİYE KONTROL VANASI (SOLENOID 24V AC)	FLEL	\$ 444	\$ 459	\$ 545	\$ 563	\$ 646	\$1.009	\$1.704
HIZLI BASINÇ (RELIEF) TAHLİYE VANASI	QR	\$ 398	\$ 414	\$ 500	\$ 518	\$ 598	\$ 934	\$1.434
ELEKTRİK FLATÖRLÜ SEVİYE KONTROL VANASI PANOSU	FLELP	\$453						

*Epoxy Kırmızı renk standarttır.

*Fiyatlar USD'dir ve KDV dahil değildir.

armex

Model AX-T, Pik Döküm (GG25), Dişli, 230 PSI

CE
TSE
EN 1074-5

ÜRÜN ADI	ÇAP KOD	2" Ø50	2½" Ø65	3" Ø80
BASIC VANA	B	\$ 83	\$ 92	\$ 101
MANUEL KONTROL VANASI	M	\$ 174	\$ 182	\$ 190
SOLENOID KONTROL VANASI (SOLENOID 24V AC)	EL	\$ 345	\$ 354	\$ 362
BASINÇ DÜŞÜRÜCÜ VANA	PR	\$ 343	\$ 352	\$ 359
SOLENOID KONTROLLÜ BASINÇ DÜŞÜRÜCÜ VANA	PREL	\$ 506	\$ 514	\$ 522
BASINÇ SABİTLEME VANASI	PS	\$ 357	\$ 365	\$ 373
BASINÇ DÜŞÜRÜCÜ VE BASINÇ SABİTLEME VANASI	PRPS	\$ 533	\$ 542	\$ 549
FLATÖRLÜ SEVİYE KONTROL VANASI	FL	\$ 285	\$ 294	\$ 302
ELEKTRİK FLATÖRLÜ SEVİYE KONTROL VANASI (SOLENOID 24V AC)	FLEL	\$ 416	\$ 424	\$ 432
HIZLI BASINÇ (RELIEF) TAHLİYE VANASI	QR	\$ 370	\$ 379	\$ 387
ELEKTRİK FLATÖRLÜ SEVİYE KONTROL VANASI PANOSU	FLELP	\$453		



02.02.2026



EN 1074-5

Model 64 -PN16, Sfero Döküm (GGG40), Dişli, 230 PSI - Açılı

ÜRÜN ADI	ÇAP KOD	2" Ø50	2½" Ø65	3" Ø80
BASIC VANA	B	\$ 122	\$ 142	\$ 283
MANUEL KONTROL VANASI	M	\$231	\$251	\$ 392
BASINÇ DÜŞÜRÜCÜ VANA	PR	\$438	\$452	\$ 584
SOLENOID KONTROLLÜ BASINÇ DÜŞÜRÜCÜ VANA (SOLENOID 24V AC)	PREL	\$719	\$734	\$ 865
BASINÇ SABİTLEME VANASI	PS	\$450	\$465	\$ 592
BASINÇ DÜŞÜRÜCÜ VE BASINÇ SABİTLEME VANASI	PRPS	\$662	\$677	\$ 793
FLATÖRLÜ SEVİYE KONTROL VANASI	FL	\$438	\$456	\$ 597
AKIŞ MİKTARI (DEBİ) KONTROL VANASI	FR	\$917	\$958	\$1.093
HIZLI BASINÇ (RELIEF) TAHLİYE VANASI	QR	\$472	\$487	\$ 607
SOLENOID KONTROL VANASI (SOLENOID 24V AC)	EL/G	\$517	\$532	\$ 675
UZAKTAN KONTROL VANASI	RC	\$359	\$374	\$ 504
ELEKTRİK FLATÖRLÜ SEVİYE KONTROL VANASI (SOLENOID 24V AC)	FLEL	\$605	\$626	\$ 767

İLAVE ÜCRETLER	ÇAP KOD	2" Ø50	2½" Ø65	3" Ø80
POZİSYON İNDİKATÖR MİLİ	I	\$175	\$175	\$ 178
LİMİT SWITCH	LS	\$229	\$229	\$ 229
BAKIR BORULU KONTROL SİSTEMİ	CP	\$136	\$136	\$ 136
PASLANMAZ BORULU SİSTEM	SSP	\$ 73	\$ 73	\$ 88
GLİSERİNLİ MANOMETRE	PG		\$36	
ELEKTRİK FLATÖRLÜ SEVİYE KONTROL VANASI PANOSU	FLELP		\$453	

*Metal kontrol sistemi standart olup borulama hidrolik hortumdur (Air Brake Sae J 844).

*Üretici 2 veya 3 yollu kontrol sistemi kullanabilir.

*Epoxy kaplama standarttır, isteğe göre polyeester kaplama yapılabilir.

*Standart Solenoid valfler Gem-A Solenoid valf 24V AC'dir.

*Fiyatlar **USD**'dir ve KDV dahil değildir.

01.02.2026

YANGIN VANALARI

TS 12259 YANGIN VANASI



KOD	ÖLÇÜ	KOLİ	FİYAT
4620	2" TSE	20	2.500,00
6627	2" T2	20	2.029,00
6628	2" AĞIR	20	2.772,00
4621	2 1/2	15	3.429,00

YANGIN VANASI EKO TİP



KOD	ÖLÇÜ	KOLİ	FİYAT
6528	11/2x11/2	30	1.515,00
4622	2" x 11/2	25	1.886,00
6524	1" FAS	50	1.229,00

TS 12259 YANGIN VANASI DÜŞÜRÜCÜ REKORLU



KOD	ÖLÇÜ	KOLİ	FİYAT
4610	2" TSE	10	3.358,00
6629	2" T2	10	2.887,00

YANGIN VANASI DÜŞÜRÜCÜ REKORLU EKO TİP



KOD	ÖLÇÜ	KOLİ	FİYAT
4611	2"	10	2.744,00

TS 12259 YANGIN VANASI KÖRTAPALI



KOD	ÖLÇÜ	KOLİ	FİYAT
4612	2" TSE	10	3.358,00
6630	2" T2	10	2.887,00
4614	2 1/2 TSE	5	4.600,00

YANGIN VANASI KÖRTAPALI EKO TİP



KOD	ÖLÇÜ	KOLİ	FİYAT
4615	2"	10	2.744,00

TS 12259 YANGIN VANASI HORTUM REKORLU



KOD	ÖLÇÜ	KOLİ	FİYAT
4616	2" TSE	10	3.358,00
6643	2" T2	10	2.887,00
4618	2 1/2 TSE	5	4.687,00

YANGIN VANASI HORTUM REKORLU EKO TİP



KOD	ÖLÇÜ	KOLİ	FİYAT
4619	2"	10	2.744,00

21/2 İTFAİYE BAĞLANTI AĞZI



KOD	ÖLÇÜ	KOLİ	FİYAT
4623	21/2 x 2" x 2"	10	6.000,00
4624	21/2x2"x21/2	8	6.286,00
4625	21/2x21/2x21/2	6	6.572,00

4" İTFAİYE BAĞLANTI AĞZI



KOD	ÖLÇÜ	KOLİ	FİYAT
4626	4" x 2" x 2"	8	6.000,00
4627	4"x21/2x2"	7	6.286,00
4628	4"x21/2x21/2	6	6.572,00

“Sevdiği işi yapan hiçbir zaman çalışmış olmaz”.
Konfüçyus

Yer Aldığımız Bazı Projeler

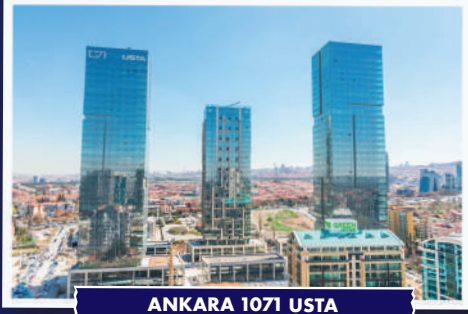

ANKARA 1071 USTA



HIGH HILL



ETLİK ŞEHİR HASTANELERİ



ANKARA AKM-GAR-KIZILAY METRO

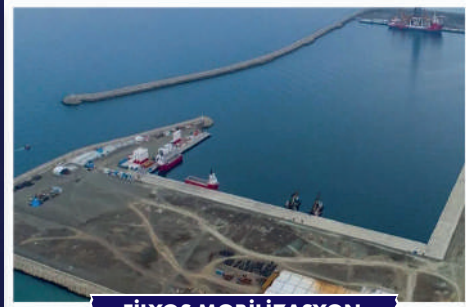

FİLYOS MOBİLİZASYON



AŞI FABRİKASI

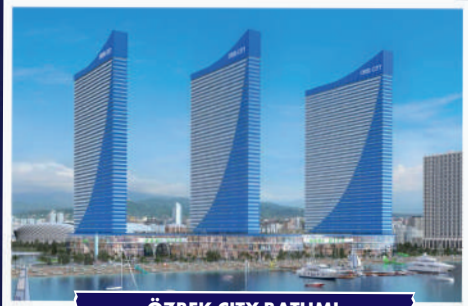

ÖZBEK CITY BATUMI



VON HOTEL ÖZDERE

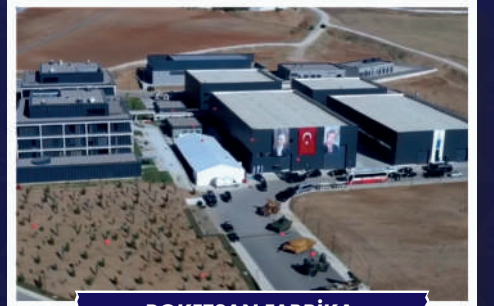

ROKETSAN FABRİKA



TAŞKENT CITY LOT



TOGG GEMLİK KAMPÜSÜ



CUBES ANKARA



ÖLÇÜM CİHAZLARI

FIYAT LİSTESİ



1986'dan beri

serdaroglu[®]

TESİSAT TEKNİK MALZEME SAN. TİC. A.Ş.

01.07.2025

MANOMETRE - TERMOMETRE

TERMOMETRE

0-120°C



	ÇAP	4 cm (₺)	10 cm (₺)	15 cm (₺)	20 cm (₺)
	ARKADAN	Ø 63	228,00	Şeffaf Plastik Arkilik Camlı ECO model sadece 0.....120°C için	
Ø 63		264,00	468,00	600,00	684,00
Ø 100		-	540,00	684,00	768,00
Ø 160		-	1.440	1.560	1.740
ALTTAN	ÇAP	4 cm (₺)	10 cm (₺)	15 cm (₺)	20 cm (₺)
	Ø 100	-	756,00	810,00	984,00
	Ø 160	-	1.560	1.680	1.450

KURU TİP MANOMETRE



ÇAP	GÖVDE KAPAK	(Cl.)	VİDA	ALTTAN (₺)	ARKADAN (₺)
Ø 50	Siyah Plastik Gövde Şeffaf Akrilik Cam	2,5	G1/4" G1/8"	259,20	295,20
Ø 63	Siyah DKT Saç Gövde Şeffaf Akrilik Cam	2,5	G1/4"	276,00	326,40
Ø 100	Siyah DKT Saç Gövde Saç Bayonet Kapak	2,5	G1/2"	475,20	570,00

GLİSERİNLİ MANOMETRE





ÇAP	GÖVDE KAPAK	(Cl.)	VİDA	ALTTAN (₺)	ARKADAN (₺)
Ø 50	AISI 304 INOX Gövde AISI 304 INOX Kapak	2,5	G1/4"	452,80	712,80
Ø 63		2,5	G1/4"	456,00	571,20
Ø 100		2,5	G1/2"	1.104	1.380,00
Ø 63 Eko		2,5	G1/4"	395,00	*

*Eko Model Plastik Gövdeli Alttan Çıkışıdır.

22.02.2023

MANOMETRELER-1

						STANDART		
040	Cl. 2,5	MANOMETRE	0/1..1,6..2,5..4..6..10..16..25..40..60..100..160..250..315..400 bar	bar/psi	040 100	<input type="checkbox"/>	Basınç Elemanı: Bakır Alaşımı	
	G 1/8"	VAKUMMETRE	-760/0 mmHg -1/0 bar Manovakummetre: -1/+0,6..1,5..3..5..9..15..24 bar	mmHg bar/psi	040 200	<input type="checkbox"/>	Bağlantı Elemanı: Pirinç	
	IP41	HİDROMETRE	0/10..16..25..40..60..100 mWS	mWS/bar	040 300	<input type="checkbox"/>	Mekanizma : Pirinç	



Metal Gövde
Akrilik Kapak
-1...60 bar
€5,80
100...400 bar
€6,00



Plastik Gövde
Akrilik Kapak
-1...60 bar
€5,50
100...400 bar
€5,70



Metal Gövde
Akrilik Kapak
-1...60 bar
€5,60
100...400 bar
€5,80

Bağlantı Tipi No : --- 01
Altan Bağlantılı



Bağlantı Tipi No : --- 02
Arkadan Bağlantılı



Bağlantı Tipi No : --- 02
Arkadan Bağlantılı



Metal Gövde
Metal Kapak
-1...60 bar
€6,60
100...400 bar
€6,80



Plastik Gövde
Akrilik Kapak
€5,50

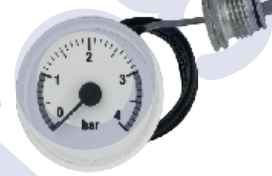

Plastik Gövde
Akrilik Kapak
€5,10

Bağlantı Tipi No : --- 03
Arkadan Bağlantılı Pano Tip





2 bar Kirlilik Göstergesi
Ürün Kodu : 040 100 02 03 10
Arkadan Bağlantılı



4 bar Kapiler Borulu (G1/4" - 1 mt)
Ürün Kodu : 040 100 09 05 10
Arkadan Bağlantılı



050	Cl. 2,5	MANOMETRE	0/0,6..1..1,6..2,5..4..6..10..16..25..40..60..100..160..250..315..400..600 bar	bar/psi	050 100	<input type="checkbox"/>	Basınç Elemanı: Bakır Alaşımı	
	G 1/4"	VAKUMMETRE	-760/0 mmHg -1/0 bar Manovakummetre: -1/+0,6..1,5..3..5..9..15..24 bar	mmHg bar/psi	050 200	<input type="checkbox"/>	Bağlantı Elemanı: Pirinç	
	IP41	HİDROMETRE	0/6..10..16..25..40..60..100 mWS	mWS/bar	050 300	<input type="checkbox"/>	Mekanizma : Pirinç	



Plastik Gövde
Akrilik Kapak
-1...60 bar
€4,70
100...600 bar
€5,00



Metal Gövde
Akrilik Kapak
-1...60 bar
€4,90
100...600 bar
€5,20



Plastik Gövde
Akrilik Kapak
-1...60 bar
€5,70
100...600 bar
€6,00

Bağlantı Tipi No : --- 01
Altan Bağlantılı



Bağlantı Tipi No : --- 01
Altan Bağlantılı



Bağlantı Tipi No : --- 02
Arkadan Bağlantılı



Metal Gövde
Akrilik Kapak
-1...60 bar
€5,90
100...600 bar
€6,20



Metal Gövde
Metal Kapak
-1...60 bar
€6,90
100...600 bar
€7,20

Bağlantı Tipi No : --- 02
Arkadan Bağlantılı











Bağlantı Tipi No : --- 03
Arkadan Bağlantılı Pano Tip







22.02.2023

MANOMETRELER-3

Ø100	Cl. 2,5	MANOMETRE	0/0,6..1..1,6..2,5..4..6..10..16..25..40..60..100..160..250..315..400..600 bar	bar/psi	100 100	<input type="checkbox"/>	Gövde: AISI 304 SS	
	G 1/2"	VAKUMMETRE	-760/0 mmHg -1/0 bar Manovakummetre: -1/+0,6..1,5..3..5..9..15..24 bar	mmHg bar/psi	100 200	<input type="checkbox"/>	Kapak: AISI 304 SS	
	IP65						Basınç Elemanı: Bakır Alaşımı	
							Bağlantı Elemanı: Pirinç	
							Mekanizma : Pirinç	
			-1...60 bar					
			€19,90					
			100...600 bar					
			€20,50					
Bağlantı Tipi No : - - - - - 11								
Alttan Bağlantılı								
			-1...60 bar					
			€24,80					
			100...600 bar					
			€25,40					
Bağlantı Tipi No : - - - - - 12								
Arkadan Bağlantılı								
			-1...60 bar					
			€29,10					
			100...600 bar					
			€29,70					
Bağlantı Tipi No : - - - - - 13								
Arkadan Bağlantılı Pano Tip								

GLİSERİN DOLGULU

Ø160	Cl. 1,6	MANOMETRE	0/2,5..4..6..10..16..25..40..60..100..160..250..315..400..600 bar	bar/psi	160 100	<input type="checkbox"/>	Gövde: AISI 304 SS	
	G 1/2"	MANOVAKUMMETRE	-1/+1,5..3..5..9..15..24 bar	bar/psi	160 200	<input type="checkbox"/>	Kapak: AISI 304 SS	
	IP65						Basınç Elemanı: Bakır Alaşımı	
							Bağlantı Elemanı: Pirinç	
							Mekanizma : Pirinç	





-1...600 bar
€43,60

Bağlantı Tipi No : - - - - - 14

6'dan beri

Bağlantı Tipi No : - - - - - 14

Ø63	Cl. 2,5	MANOMETRE	0/2,5..4..6..10..16..25..40..60..100..160..250..315..400..600 bar	bar/psi	063 101	<input type="checkbox"/>	Gövde: AISI 316L SS	
	G 1/4"	MANOVAKUMMETRE	-1/+1,5..3..5..9..15..24 bar	bar/psi	063 201	<input type="checkbox"/>	Kapak: AISI 316L SS	
	IP65						Basınç Elemanı: AISI 316L SS	
							Bağlantı Elemanı: AISI 316L SS	
							Mekanizma : Paslanmaz	



Fiyat Sorunuz



-1...600 bar
€26,70

Bağlantı Tipi No : - - - - - 21

Alttan Bağlantılı



Fiyat Sorunuz







-1...600 bar
€30,60

Bağlantı Tipi No : - - - - - 24

Arkadan Bağlantılı Eksenden Kaçık

GLİSERİN DOLGULU, KOMPLE PASLANMAZ

Ø63	Cl. 2,5	MANOMETRE	0/2,5..4..6..10..16..25..40..60..100..160..250..315..400..600 bar	bar/psi	063 101	<input type="checkbox"/>	Gövde: AISI 316L SS	
	G 1/4"	MANOVAKUMMETRE	-1/+1,5..3..5..9..15..24 bar	bar/psi	063 201	<input type="checkbox"/>	Kapak: AISI 316L SS	
	IP65						Basınç Elemanı: AISI 316L SS	
							Bağlantı Elemanı: AISI 316L SS	
							Mekanizma : Paslanmaz	



Fiyat Sorunuz



-1...600 bar
€27,10



Fiyat Sorunuz





-1...600 bar
€31,00

22.02.2023

MANOMETRELER-3



STANDART



Ø63	Cl. 2,5	MANOMETRE	0/0,6..1..1,6..2,5..4..6..10..16..25..40..60..100..160..250..315..400..600 bar	bar/psi	063 100	<input type="checkbox"/>	Basınç Elemanı: Bakır Alaşımı	
	G 1/4"	VAKUMMETRE	-760/0 mmHg -1/0 bar Manovakummetre: -1/+0,6..1,5..3..5..9..15..24 bar	mmHg bar/psi	063 200	<input type="checkbox"/>	Bağlantı Elemanı: Pirinç	
	IP41	HİDROMETRE	0/6..10..16..25..40..60..100 mWS	mWS/bar	063 300	<input type="checkbox"/>	Mekanizma : Pirinç	



	Metal Gövde Akrilik Kapak -1...60 bar €5,00 100...600 bar €5,30		Plastik Gövde Akrilik Kapak -1...60 bar €4,80 100...600 bar €5,10		Metal Gövde Metal Kapak -1...60 bar €6,10 100...600 bar €6,40
Bağlantı Tipi No : - - - - - 01 Alttan Bağlantılı		Bağlantı Tipi No : - - - - - 01 Alttan Bağlantılı		Bağlantı Tipi No : - - - - - 01 Alttan Bağlantılı	

	Metal Gövde Akrilik Kapak -1...60 bar €5,90 100...600 bar €6,20		Plastik Gövde Akrilik Kapak -1...60 bar €5,80 100...600 bar €6,10		Metal Gövde Metal Kapak -1...60 bar €7,30 100...600 bar €7,60
Bağlantı Tipi No : - - - - - 02 Arkadan Bağlantılı		Bağlantı Tipi No : - - - - - 02 Arkadan Bağlantılı		Bağlantı Tipi No : - - - - - 02 Arkadan Bağlantılı	

	Metal Gövde Metal Kapak -1...60 bar €7,30 100...600 bar €7,60		Metal Gövde Akrilik Kapak 600 mbar €6,50		
Bağlantı Tipi No : - - - - - 03 Arkadan Bağlantılı Pano Tip		Ürün Kodu : 063 100 01 18 12 Alttan Bağlantılı			

Ø100	Cl. 2,5	MANOMETRE	0/0,6..1..1,6..2,5..4..6..10..16..25..40..60..100..160..250..315..400..600 bar	bar/psi	100 100	<input type="checkbox"/>	Basınç Elemanı: Bakır Alaşımı	
	G 1/2"	VAKUMMETRE	-760/0 mmHg -1/0 bar Manovakummetre: -1/+0,6..1,5..3..5..9..15..24 bar	mmHg bar/psi	100 200	<input type="checkbox"/>	Bağlantı Elemanı: Pirinç	
	IP41	HİDROMETRE	0/6..10..16..25..40..60..100 mWS	mWS/bar	100 300	<input type="checkbox"/>	Mekanizma : Pirinç	

	Metal Gövde Metal Kapak -1...60 bar €10,80 100...600 bar €11,10		Metal Gövde Akrilik Kapak -1...60 bar €8,60 100...600 bar €8,90		Metal Gövde Metal Kapak -1...60 bar €10,40 100...600 bar €10,70
Bağlantı Tipi No : - - - - - 01 Alttan Bağlantılı		Bağlantı Tipi No : - - - - - 01 Alttan Bağlantılı		Bağlantı Tipi No : - - - - - 02 Arkadan Bağlantılı	G 1/4" 

	Hidrometre İkaz İbrelili (0/6..100 mWS/bar) Metal Gövde Akrilik Kapak €9,10				
Bağlantı Tipi No : - - - - - 01 Alttan Bağlantılı					

22.02.2023

MANOMETRELER- 4

STANDART

Ø160

Cl. 1,6
G 1/2"
IP65

MANOMETRE 0/1..1,6..2,5..4..6..10..16..25..40..60..100..160..250..315..400..600 bar

bar/psi

160 100

VAKUMMETRE -760/0 mmHg -1/0 bar Manovakummetre: -1/+0,6..1,5..3..5..9..15..24 bar

mmHg bar/psi

160 200
 Gövde: AISI 304 SS
 Kapak: AISI 304 SS
 Basınç Elemanı: Bakır Alaşımı
 Bağlantı Elemanı: Pirinç
 Mekanizma : Pirinç

Kuru Tip

0...6 bar
-1...5 bar

€37,20



Doldurulabilir Tip

10..60 bar
-1/9...24 bar

€35,20

100...600 bar
€36,00Bağlantı Tipi No : - - - - - 71 Doldurulamaz

Bağlantı Tipi No : - - - - - 21

Alttan Bağlantılı



GLİSERİN DOLGULU

Ø40

Cl. 2,5
G 1/8"
IP67

MANOMETRE 0/1..1,6..2,5..4..6..10..16..25..40..60..100..160..250..315..400 bar

bar/psi

040 100

VAKUMMETRE -760/0 mmHg -1/0 bar Manovakummetre: -1/+0,6..1,5..3..5..9..15..24 bar

mmHg bar/psi

040 200
 Gövde: AISI 304 SS
 Kapak: AISI 304 SS
 Basınç Elemanı: Bakır Alaşımı
 Bağlantı Elemanı: Pirinç
 Mekanizma : Pirinç
-1...400 bar
€13,80

Bağlantı Tipi No : - - - - - 12

Arkadan Bağlantılı



Ø50

Cl. 2,5
G 1/4"
IP65

MANOMETRE 0/0,6..1..1,6..2,5..4..6..10..16..25..40..60..100..160..250..315..400..600 bar

bar/psi

050 100

VAKUMMETRE -760/0 mmHg -1/0 bar Manovakummetre: -1/+0,6..1,5..3..5..9..15..24 bar

mmHg bar/psi

050 200
 Gövde: AISI 304 SS
 Kapak: AISI 304 SS
 Basınç Elemanı: Bakır Alaşımı
 Bağlantı Elemanı: Pirinç
 Mekanizma : Pirinç
-1...60 bar
€9,40100...600 bar
€9,50

Bağlantı Tipi No : - - - - - 11

Alttan Bağlantılı

-1...60 bar
€12,80100...600 bar
€12,90

Bağlantı Tipi No : - - - - - 12

Arkadan Bağlantılı

-1...60 bar
€13,60100...600 bar
€13,90

Bağlantı Tipi No : - - - - - 13

Arkadan Bağlantılı Panotip



Ø63

Cl. 2,5
G 1/4"
IP65

MANOMETRE 0/0,6..1..1,6..2,5..4..6..10..16..25..40..60..100..160..250..315..400..600 bar

bar/psi

063 100

VAKUMMETRE -760/0 mmHg -1/0 bar Manovakummetre: -1/+0,6..1,5..3..5..9..15..24 bar

mmHg bar/psi

063 200
 Gövde: AISI 304 SS
 Kapak: AISI 304 SS
 Basınç Elemanı: Bakır Alaşımı
 Bağlantı Elemanı: Pirinç
 Mekanizma : Pirinç
-1...60 bar
€8,30100...600 bar
€8,60

Bağlantı Tipi No : - - - - - 11

Alttan Bağlantılı

-1...60 bar
€10,30100...600 bar
€10,60

Bağlantı Tipi No : - - - - - 12

Arkadan Bağlantılı

-1...60 bar
€11,90100...600 bar
€12,20





Bağlantı Tipi No : - - - - - 13

Arkadan Bağlantılı Panotip



22.02.2023

MANOMETRELER-5

Ø160	Cl. 1,6	MANOMETRE	0/1..1,6..2,5..4..6..10..16..25..40..60..100..160..250..315..400..600 bar	bar/psi	160 100	<input type="checkbox"/>	Gövde: AISI 304 SS	   
	G 1/2"	VAKUMMETRE	-760/0 mmHg -1/0 bar Manovakummetre: -1/+0,6..1,5..3..5..9..15..24 bar	mmHg bar/psi	160 200	<input type="checkbox"/>	Kapak: AISI 304 SS Basınç Elemanı: Bakır Alaşımı Bağlantı Elemanı: Pirinç Mekanizma : Pirinç	
	IP65							



Kuru Tip
0...6 bar
-1...5 bar
€37,20

Bağlantı Tipi No : - - - - - **71** Doldurulamaz

Alttan Bağlantılı







Doldurulabilir Tip
10...60 bar
-1/9...24 bar
€35,20
100...600 bar
€36,00

Bağlantı Tipi No : - - - - - **21**

Alttan Bağlantılı

GLİSERİN DOLGULU





Ø40	Cl. 2,5	MANOMETRE	0/1..1,6..2,5..4..6..10..16..25..40..60..100..160..250..315..400 bar	bar/psi	040 100	<input type="checkbox"/>	Gövde: AISI 304 SS	   
	G 1/8"	VAKUMMETRE	-760/0 mmHg -1/0 bar Manovakummetre: -1/+0,6..1,5..3..5..9..15..24 bar	mmHg bar/psi	040 200	<input type="checkbox"/>	Kapak: AISI 304 SS Basınç Elemanı: Bakır Alaşımı Bağlantı Elemanı: Pirinç Mekanizma : Pirinç	
	IP67							



-1...400 bar
€13,80

Bağlantı Tipi No : - - - - - **12**

Arkadan Bağlantılı

Ø50	Cl. 2,5	MANOMETRE	0/0,6..1..1,6..2,5..4..6..10..16..25..40..60..100..160..250..315..400..600 bar	bar/psi	050 100	<input type="checkbox"/>	Gövde: AISI 304 SS	   
	G 1/4"	VAKUMMETRE	-760/0 mmHg -1/0 bar Manovakummetre: -1/+0,6..1,5..3..5..9..15..24 bar	mmHg bar/psi	050 200	<input type="checkbox"/>	Kapak: AISI 304 SS Basınç Elemanı: Bakır Alaşımı Bağlantı Elemanı: Pirinç Mekanizma : Pirinç	
	IP65							



-1...60 bar
€9,40
100...600 bar
€9,50

Bağlantı Tipi No : - - - - - **11**

Alttan Bağlantılı



-1...60 bar
€12,80
100...600 bar
€12,90

Bağlantı Tipi No : - - - - - **12**





Arkadan Bağlantılı



-1...60 bar
€13,60
100...600 bar
€13,90

Bağlantı Tipi No : - - - - - **13**

Arkadan Bağlantılı Panotip

Ø63	Cl. 2,5	MANOMETRE	0/0,6..1..1,6..2,5..4..6..10..16..25..40..60..100..160..250..315..400..600 bar	bar/psi	063 100	<input type="checkbox"/>	Gövde: AISI 304 SS	   
	G 1/4"	VAKUMMETRE	-760/0 mmHg -1/0 bar Manovakummetre: -1/+0,6..1,5..3..5..9..15..24 bar	mmHg bar/psi	063 200	<input type="checkbox"/>	Kapak: AISI 304 SS Basınç Elemanı: Bakır Alaşımı Bağlantı Elemanı: Pirinç Mekanizma : Pirinç	
	IP65							



-1...60 bar
€8,30
100...600 bar
€8,60

Bağlantı Tipi No : - - - - - **11**

Alttan Bağlantılı



-1...60 bar
€10,30
100...600 bar
€10,60

Bağlantı Tipi No : - - - - - **12**

Arkadan Bağlantılı



-1...60 bar
€11,90
100...600 bar
€12,20

Bağlantı Tipi No : - - - - - **13**

Arkadan Bağlantılı Panotip

22.02.2023

TERMOMETRE

STANDART

Ø63

Cl. 2,0

G 1/2"

TERMOMETRE

IP51

-30...+60*, 0...+120*, 160*, 200*, 250, 300, 350, 400, 500 °C

°C

063 402

 Gövde: AISI 430 SS
 Kapak: AISI 430 SS
 Termovül: AISI 316L SS
 5 cm termovüller piring üretilir.

Model No: 063 402

Arkadan Bağlantılı

Dalma Boyu		€
* 5 cm	25 ad.	5,00
10 cm	2 ad.	8,80
15 cm	2 ad.	11,30
20 cm	1 ad.	12,90
25 cm	1 ad.	14,30
30 cm	1 ad.	15,00
40 cm	1 ad.	18,20
50 cm	1 ad.	21,60

Ø100

Cl. 2,0

G 1/2"

TERMOMETRE

IP51

-30...+60, 0...+120, 160, 200, 250, 300, 350, 400, 500 °C

°C

100 401

 Gövde: AISI 430 SS
 Kapak: AISI 430 SS
 Termovül: AISI 316L SS
 5 cm termovüller piring üretilir.

-30...+60*, 0...+120*, 160*, 200*, 250, 300, 350, 400, 500 °C

°C

100 402

* Sadece 5 cm. için mevcut sıcaklık skalaları

 Gövde:
 Metal (Siyah Boyalı)
 Kapak:
 Metal (Bayonet)

Model No: 100 401

Alttan Bağlantılı

Dalma Boyu		€
10 cm	4 ad.	14,30
15 cm	2 ad.	15,30
20 cm	2 ad.	18,60
25 cm	1 ad.	20,20
30 cm	1 ad.	21,10
40 cm	1 ad.	23,10
50 cm	1 ad.	26,20
70 cm	1 ad.	34,20
100 cm	1 ad.	44,40



Model No: 100 402

Arkadan Bağlantılı

Dalma Boyu		€
5 cm	6 ad.	6,30
10 cm	4 ad.	10,20
15 cm	2 ad.	12,90
20 cm	2 ad.	14,50
25 cm	2 ad.	15,80
30 cm	1 ad.	17,10
40 cm	1 ad.	19,90
50 cm	1 ad.	23,70
70 cm	1 ad.	30,00
100 cm	1 ad.	39,50

Ø160

Cl. 2,0

G 1/2"

TERMOMETRE

IP51

-30...+60, 0...+120, 160, 200, 250, 300, 350, 400, 500 °C

°C

160 401

 Gövde: Metal (Siyah Boyalı)
 Kapak: Metal, Bayonet
 Termovül: AISI 316L SS

-30...+60, 0...+120, 160, 200, 250, 300, 350, 400, 500 °C

°C

160 402

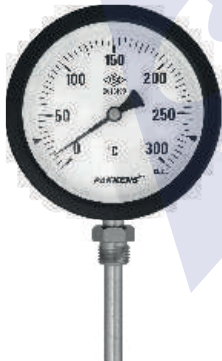

Model No: 160 401

Alttan Bağlantılı

Dalma Boyu		€
10 cm	1 ad.	29,10
15 cm	1 ad.	31,20
20 cm	1 ad.	33,00
25 cm	1 ad.	34,60
30 cm	1 ad.	36,20
40 cm	1 ad.	39,20
50 cm	1 ad.	43,20
70 cm	1 ad.	50,20
100 cm	1 ad.	60,50



Model No: 160 402

Arkadan Bağlantılı

Dalma Boyu		€
10 cm	1 ad.	26,40
15 cm	1 ad.	27,20
20 cm	1 ad.	30,60
25 cm	1 ad.	32,40
30 cm	1 ad.	34,00
40 cm	1 ad.	35,50
50 cm	1 ad.	40,40
70 cm	1 ad.	45,20
100 cm	1 ad.	53,80

ISITMA TESİSATI

FIYAT LİSTESİ



1986'dan beri

serdaroglu[®]

TESİSAT TEKNİK MALZEME SAN. TİC. A.Ş.



01.02.2026

SAP No	Logamax Plus GB172i.2	Görsel	Nominal Isıtma Gücü	Çalışma Basıncı	Kazan Fiyatı
7736902452	 GB172i.2-35		50/30 °C - 35 kW 80/60 °C - 33,6 kW	3 bar	2.370 EUR
7736902503	 GB172i.2-40		50/30 °C - 40 kW 80/60 °C - 39,8 kW	3 bar	2.550 EUR
7736902504	 GB172i.2-45		50/30 °C - 45 kW 80/60 °C - 42,6 kW	3 bar	2.800 EUR

* GB172i.2 serisi kazanlarda denge kabı ve ilave pompa kullanılarak sistem çözümü yapılmalıdır.

 ERP Enerji etiketleme tablosu kapsamı 70kW ve altı cihazları kapsamaktadır. (80°/60° su rejiminde)









BUDERUS GB272 SERİSİ DUVAR TIPI YOĞUŞMALI KAZAN FİYAT LİSTESİ

SAP No	Logamax Plus GB272	Görsel	Nominal Isıtma Gücü	Çalışma Basıncı	Kazan Fiyatı
7736702188	 GB272-49		50/30 °C - 49,9 kW 80/60 °C - 46,5 kW	6 bar	3.500 EUR
7736702189	 GB272-69		50/30 °C - 69,5 kW 80/60 °C - 62,6 kW	6 bar	3.840 EUR
7736702191	GB272-100		50/30 °C - 99,5 kW 80/60 °C - 94,5 kW	6 bar	3.950 EUR
7736702192	GB272-125		50/30 °C - 124,5 kW 80/60 °C - 118,1 kW	6 bar	4.930 EUR
7736702193	GB272-150		50/30 °C - 146 kW 80/60 °C - 141,7 kW	6 bar	5.580 EUR

* Görseldeki fotoğraf; GB272 kazanın izolasyon dahil pompa ve hızlı montaj ünitesi ile olan görüntüsüdür.

 Görseldeki enerji sınıfı GB272-49 ve GB272-69 model cihaz içindir. ERP Enerji etiketleme tablosu kapsamı 70kW ve altı cihazları kapsamaktadır. (80°/60° su rejiminde)

BUDERUS BOYLERLER ve AKUMULASYON TANKLARI FİYAT LİSTESİ

SAP No	Dik Tip duoCLEAN Hijyenik Boylerler	Görsel	Depo Hacmi	* Kapasite Soğuk Su Girişi: 10 °C Boiler Su Çıkışı: 45 °C	Fiyat
8718542406	S 120 / 5W (Beyaz) 	  	120 litre	834 l/h	1.270 EUR
8718543049	SU 120 / 5W (Beyaz) 		120 litre	736 l/h	1.270 EUR
8718543058	SU 160 / 5W (Beyaz) 		160 litre	736 l/h	1.310 EUR
8718543067	SU 200 / 5W (Beyaz) 		200 litre	736 l/h	1.425 EUR
7735502328	SU 300 / 5W-B (Beyaz) 		300 litre	896 l/h	1.860 EUR
7736502250	SU 500 / 5C (Mavi) 		500 litre	1.620 l/h	3.335 EUR
7736502262	SU 750 / 5C (Mavi)		750 litre	2.520 l/h	4.255 EUR
7736502270	SU 1000 / 5C (Mavi)		1.000 litre	2.760 l/h	4.715 EUR

- S 120 boylere üstten, SU 120 boylere arkadan bağlantı yapılır. SU 120 boylerin üstünde müdahale kapağı varken, S 120 boylerde yoktur.

- Boyler kapasiteleri; serpantin su giriş sıcaklığı 80°C'ye göre verilmiştir.

SAP No	Güneş Enerjisi Sistemleri İçin Çift Serpantinli Dik Tip Boylerler	Görsel	Depo Hacmi	Fiyat
8732928458	SM 310 / 5ES-B (Gümüş) 	  	300 litre	2.300 EUR
7735501582	SM 500 / 5ES-B (Gümüş) 		500 litre	4.195 EUR
7736502290	SM 750 / 5E-C (Mavi)		750 litre	4.655 EUR
7736502298	SM 1000 / 5E-C (Mavi)		1.000 litre	5.345 EUR

SAP No	Dik Tip Akümülayon Tankları	Depo Hacmi	Fiyat
7736502322	SF 500 / 5C (Mavi)  Serpantinsiz Dik Tip Akümülayon Tankı	500 litre	3.330 EUR
7736502334	SF 750 / 5C (Mavi) Serpantinsiz Dik Tip Akümülayon Tankı	750 litre	3.975 EUR
7736502342	SF 1000 / 5C (Mavi) Serpantinsiz Dik Tip Akümülayon Tankı	1.000 litre	4.805 EUR

- ERP yönetmeliğine göre 500 L üzeri kapasiteye sahip cihazlarda, eco label (enerji etiketi) uygulaması zorunluluğu bulunmamaktadır.

- Tüm boylerlerin işletme basıncı 10 bar'dır. 9 bar emniyet ventili kullanma zorunluluğu vardır.

01.07.2025

GENLEŞME TANKLARI

Wates-01.07.2025			
Hacim (Litre)	10 Bar	16 Bar	25 Bar
2 lt dik genişleme tankı 10 bar	\$16,15		
5 lt dik genişleme tankı 10 bar	\$18,24		
8 lt dik genişleme tankı 10 bar	\$20,78	\$26,98	\$59,67
12 lt dik genişleme tankı 10 bar	\$21,85	\$26,98	\$59,67
19 lt dik genişleme tankı 10 bar	\$26,22	\$34,76	\$83,20
24 lt küre tank 10 bar	\$26,22	\$36,60	\$83,20
24 lt yatık genişleme tankı 10 bar	\$33,02	\$39,58	\$88,51
24 lt dik genişleme tankı 10 bar	\$28,09	\$36,60	\$83,20
35 lt tank 10 bar	\$43,47	\$65,11	\$122,04
50 lt ayaksız tank 10 bar	\$46,80	\$73,25	\$129,15
50 lt dik genişleme tankı 10 bar	\$50,00	\$73,25	\$130,04
50 lt yatık genişleme tankı 10 bar	\$50,55	\$73,25	\$130,04
60 lt dik genişleme tankı 10 bar	\$61,24	\$81,38	\$146,76
60 lt yatık genişleme tankı 10 bar	\$61,24	\$81,38	\$146,76
80 lt dik genişleme tankı 10 bar	\$87,56	\$111,69	\$210,44
80 lt yatık genişleme tankı 10 bar	\$91,76	\$111,69	\$210,44
100 lt dik genişleme tankı 10 bar	\$91,23	\$120,73	\$266,60
100 lt yatık genişleme tankı 10 bar	\$90,91	\$120,73	\$266,62
150 lt dik genişleme tankı 10 bar	\$127,27	\$140,51	\$393,93
200 lt dik genişleme tankı 10 bar	\$171,71	\$250,47	\$543,82
300 lt dik genişleme tankı 10 bar	\$193,80	\$295,27	\$741,65
500 lt dik genişleme tankı 10 bar	\$299,02	\$402,35	\$1.016,22
750 lt dik genişleme tankı 10 bar	\$431,68	\$916,36	\$1.687,04
900 lt dik genişleme tankı 10 bar	\$498,18	\$957,09	\$1.755,42
1000 lt dik genişleme tankı 10 bar	\$550,18	\$1.160,73	\$2.061,04
1250 lt dik genişleme tankı 10 bar	\$1.045,96	\$1.486,55	\$2.346,07
1500 lt dik genişleme tankı 10 bar	\$1.099,64	\$1.573,51	\$2.571,11
2000 lt dik genişleme tankı 10 bar	\$1.519,71	\$2.200,87	\$3.850,67
2500 lt dik genişleme tankı 10 bar	\$1.812,36	\$2.443,64	\$4.645,87
3000 lt dik genişleme tankı 10 bar	\$2.769,45	\$3.461,82	\$5.517,33
4000 lt dik genişleme tankı 10 bar	\$4.581,04	\$6.109,09	\$8.281,09
5000 lt dik genişleme tankı 10 bar	\$6.414,55	\$7.803,31	\$10.293,71



01.04.2026

BASIC MODEL TANKLAR

KBS-B SERİSİ TEK SERPANTİNLİ BOYLER



	KOD	LİSTE
6 BAR	KBS-B-0100	398 €
	KBS-B-0160	474 €
	KBS-B-0200	502 €
	KBS-B-0300-0	560 €
	KBS-B-0500	777 €
10 BAR	KBS-B-0800	1.311 €
	KBS-B-1000	1.350 €
	KBS-B-1500	1.954 €
	KBS-B-2000	2.817 €
	KBS-B-2500	4.094 €
	KBS-B-3000	4.793 €

KBD-B SERİSİ ÇİFT SERPANTİNLİ BOYLER



	KOD	LİSTE
6 BAR	KBD-B-0160	532 €
	KBD-B-0200	560 €
	KBD-B-0300-0	627 €
	KBD-B-0500	882 €
	KBD-B-0800	1.511 €
10 BAR	KBD-B-1000	1.555 €
	KBD-B-1500	2.180 €
	KBD-B-2000	3.061 €
	KBD-B-2500	4.676 €
	KBD-B-3000	6.144 €

KAT-B SERİSİ AKÜMÜLASYON TANKI



	KOD	LİSTE
6 BAR	KAT-B-0100	371 €
	KAT-B-0160	446 €
	KAT-B-0200	448 €
	KAT-B-0300-0	557 €
	KAT-B-0500	725 €
	KAT-B-0800	1.038 €
	KAT-B-1000	1.142 €
10 BAR	KAT-B-1500	1.583 €
	KAT-B-2000	2.120 €
	KAT-B-2500	2.973 €
	KAT-B-3000	3.698 €
	KAT-B-4000	5.821 €
KAT-B-5000	6.984 €	

01.04.2026

PRO MODEL TANKLAR

KBS SERİSİ TEK SERPANTİNLİ BOYLER



KOD	LİSTE
KBS-0100	427 €
KBS-0160	534 €
KBS-0200	554 €
KBS-0300-0	608 €
10 BAR	
KBS-0500	854 €
KBS-0800	1.774 €
KBS-1000	1.842 €
KBS-1500	2.686 €
KBS-2000	3.585 €
KBS-2500	5.085 €
KBS-3000	5.885 €

KBD SERİSİ ÇİFT SERPANTİNLİ BOYLER



KOD	LİSTE
KBD-0160	561 €
KBD-0200	587 €
KBD-0300-0	684 €
KBD-0500	990 €
10 BAR	
KBD-0800	1.928 €
KBD-1000	2.102 €
KBD-1500	2.948 €
KBD-2000	3.918 €
KBD-2500	5.892 €
KBD-3000	7.288 €

KAT SERİSİ AKÜMÜLASYON TANKI



KOD	LİSTE
KAT-0100	389 €
KAT-0160	463 €
KAT-0200	474 €
KAT-0300-0	584 €
KAT-0500	733 €
10 BAR	
KAT-0800	1.424 €
KAT-1000	1.630 €
KAT-1500	2.262 €
KAT-2000	3.072 €
KAT-2500	3.748 €
KAT-3000	4.527 €
KAT-4000	7.121 €
KAT-5000	9.045 €

01.04.2026

BUFFER TANKLAR

KBT-B SERİSİ ISITMA BUFFER TANK



KOD	LİSTE
KBT-B-0100	281 €
KBT-B-0160	326 €
KBT-B-0200	345 €
KBT-B-0300	389 €
KBT-B-0500	515 €
KBT-B-0800	800 €
KBT-B-1000	867 €
KBT-B-1500	1.244 €
KBT-B-2000	1.763 €
KBT-B-2500	Fiyat bilgisi için iletişime geçiniz.
KBT-B-3000	Fiyat bilgisi için iletişime geçiniz.
KBT-B-4000	Fiyat bilgisi için iletişime geçiniz.
KBT-B-5000	Fiyat bilgisi için iletişime geçiniz.

KBT-CB SERİSİ SOĞUTMA BUFFER TANK



KOD	LİSTE
KBT-CB-0100	259 €
KBT-CB-0300	366 €
KBT-CB-0500	482 €
KBT-CB-0800	912 €
KBT-CB-1000	990 €
KBT-CB-1500	1.423 €
KBT-CB-2000	1.947 €
KBT-CB-2500	2.916 €
KBT-CB-3000	3.382 €
KBT-CB-4000	5.666 €
KBT-CB-5000	7.323 €

KBT-C SERİSİ PERDELİ BUFFER TANK



KOD	LİSTE
KBT-C-0100	281 €
KBT-C-0300	406 €
KBT-C-0500	589 €
KBT-C-0800	895 €
KBT-C-1000	1.002 €
KBT-C-1500	1.411 €
KBT-C-2000	1.921 €
KBT-C-2500	2.791 €
KBT-C-3000	3.527 €
KBT-C-4000	6.134 €
KBT-C-5000	8.109 €

01.04.2026

SEPERATÖR GRUPLARI

KDT SERİSİ DENGE TANKI

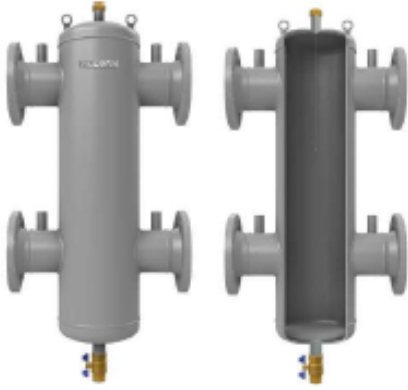

KOD	KAYNAKLI	FLANŞLI
KDT-0050	92 €	137 €
KDT-0065	97 €	147 €
KDT-0080	130 €	192 €
KDT-0100	141 €	210 €
KDT-0125	267 €	353 €
KDT-0150	370 €	488 €
KDT-0200	519 €	680 €
KDT-0250	553 €	869 €
KDT-0300	830 €	1.230 €

* DN350 ve üzeri bağlantı çapları için iletişime geçiniz.

KHA SERİSİ HAVA AYIRICI



KOD	KAYNAKLI	FLANŞLI
KHA-0050	101 €	123 €
KHA-0065	109 €	134 €
KHA-0080	129 €	160 €
KHA-0100	141 €	175 €
KHA-0125	229 €	271 €
KHA-0150	236 €	295 €
KHA-0200	315 €	395 €
KHA-0250	293 €	451 €
KHA-0300	423 €	623 €

* DN350 ve üzeri bağlantı çapları için iletişime geçiniz.

KTT SERİSİ TORTU TUTUCU

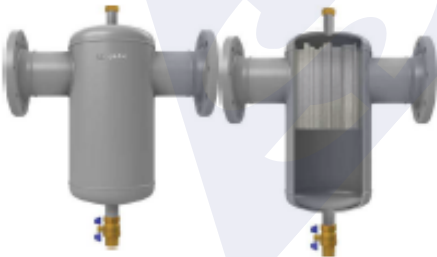

KOD	KAYNAKLI	FLANŞLI
KTT-0050	68 €	90 €
KTT-0065	72 €	97 €
KTT-0080	90 €	121 €
KTT-0100	99 €	134 €
KTT-0125	184 €	227 €
KTT-0150	188 €	247 €
KTT-0200	249 €	329 €
KTT-0250	285 €	443 €
KTT-0300	455 €	655 €

* DN350 ve üzeri bağlantı çapları için iletişime geçiniz.

01.04.2026

PAKET SEPERATÖR GRUPLARI

KPD SERİSİ PAKET DENGE TANKI

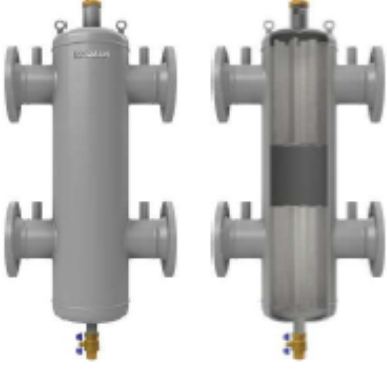

	KOD	KAYNAKLI	FLANŞLI
10 BAR	KPD-0050	125 €	169 €
	KPD-0065	134 €	185 €
	KPD-0080	170 €	232 €
	KPD-0100	183 €	252 €
	KPD-0125	367 €	452 €
	KPD-0150	453 €	571 €
	KPD-0200	646 €	807 €
	KPD-0250	696 €	1.012 €
	KPD-0300	1.005 €	1.405 €

* DN350 ve üzeri bağlantı çapları için iletişime geçiniz.

KPH SERİSİ PAKET HAVA AYIRICI

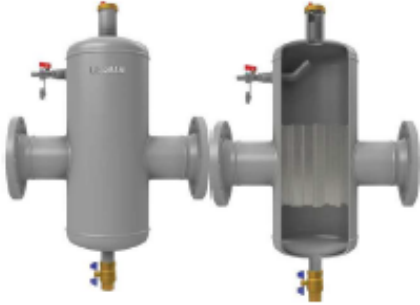

	KOD	KAYNAKLI	FLANŞLI
10 BAR	KPH-0050	195 €	217 €
	KPH-0065	207 €	232 €
	KPH-0080	194 €	225 €
	KPH-0100	209 €	244 €
	KPH-0125	339 €	382 €
	KPH-0150	339 €	398 €
	KPH-0200	443 €	523 €
	KPH-0250	501 €	659 €
	KPH-0300	491 €	691 €

* DN350 ve üzeri bağlantı çapları için iletişime geçiniz.

KMPH SERİSİ MANYETİK PAKET HAVA AYIRICI

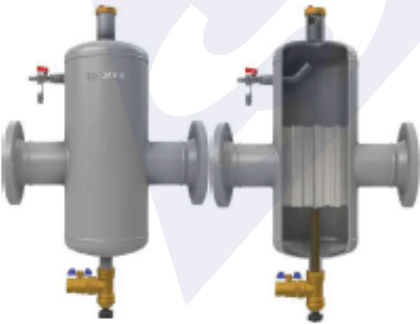

	KOD	KAYNAKLI	FLANŞLI
10 BAR	KMPH-0050	352 €	374 €
	KMPH-0065	374 €	399 €
	KMPH-0080	427 €	457 €
	KMPH-0100	454 €	489 €
	KMPH-0125	596 €	639 €
	KMPH-0150	609 €	668 €
	KMPH-0200	752 €	833 €

* DN250 ve üzeri bağlantı çapları için iletişime geçiniz.

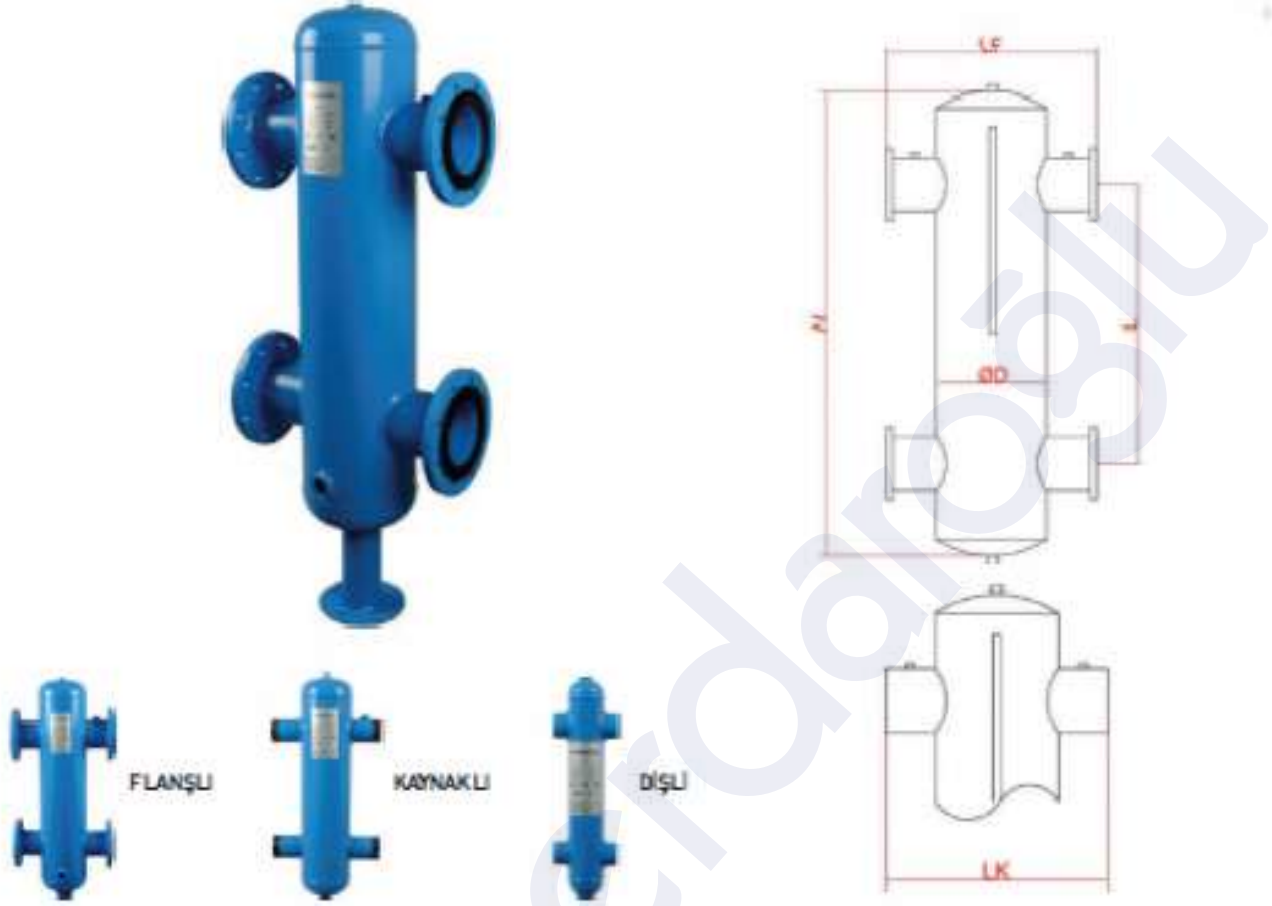

DENGE KABİ 10 BAR

BAĞLANTI ÇAPI	MAKS. KAPASİTE	GÖVDE ÇAPI	FİYAT LİSTESİ		
			DN	KW	Ø MM
DN25	20	76	₺ 1.155,00	₺ 1.155,00	₺ 1.732,50
DN32	29	76	₺ 1.232,00	₺ 1.232,00	₺ 2.156,00
DN40	43	89	₺ 1.424,50	₺ 1.424,50	₺ 2.387,00
DN50	70	114	₺ 1.925,00	₺ 1.925,00	₺ 3.234,00
DN65	140	168	₺ 2.849,00	₺ 2.849,00	₺ 4.427,50
DN80	210	219	₺ 4.774,00	₺ 4.774,00	₺ 6.352,50
DN100	350	219	₺ 5.236,00	₺ 5.236,00	₺ 7.122,50
DN125	550	273	₺ 7.700,00		₺ 10.010,00
DN150	900	323	₺ 12.705,00		₺ 16.170,00
DN200	1750	406	₺ 17.325,00		₺ 23.100,00
DN250	3250	480	₺ 28.490,00		₺ 40.040,00
DN300	5250	610	₺ 37.730,00		₺ 56.210,00

2025

SEPERATÖRLER-2

HAVA AYIRICI

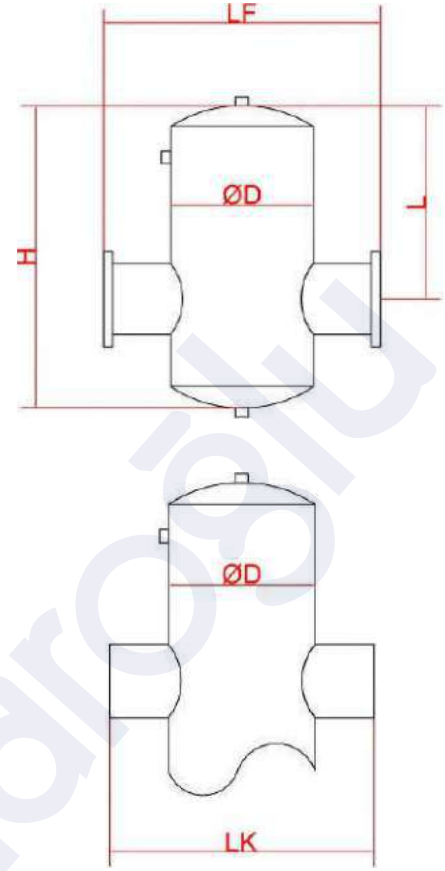

HAVA AYIRICI 10 BAR

BAĞLANTI ÇAPI	GÖVDE ÇAPI	FİYAT LİSTESİ		
		K. BOYUNLU	DİŞLİ	FLANŞLI
DN	Ø MM			
DN25	89	₺1.232,00	₺1.232,00	₺1.501,50
DN32	89	₺1.540,00	₺1.540,00	₺1.925,00
DN40	114	₺1.617,00	₺1.617,00	₺2.002,00
DN50	140	₺2.310,00	₺2.310,00	₺2.849,00
DN65	168	₺2.271,50	₺2.271,50	₺3.234,00
DN80	219	₺3.465,00	₺3.465,00	₺4.312,00
DN100	219	₺3.850,00	₺3.850,00	₺4.774,00
DN125	273	₺5.005,00		₺6.352,50
DN150	323	₺6.930,00		₺8.855,00
DN200	400	₺9.625,00		₺11.935,00
DN250	480	₺19.250,00		₺23.870,00
DN300	600	₺25.795,00		₺34.650,00

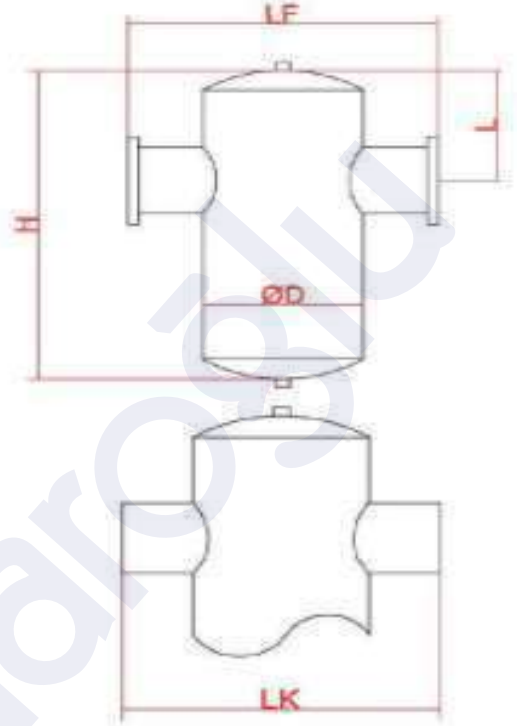
**TORTU AYIRICI 10 BAR**

BAĞLANTI ÇAPI		GÖVDE ÇAPI		FİYAT LİSTESİ		
DN	Ø MM	K. BOYUNLU	DİŞLİ	FLANŞLI		
DN25	89	₺1.232,00	₺1.232,00	₺1.501,50		
DN32	89	₺1.540,00	₺1.540,00	₺1.925,00		
DN40	114	₺1.617,00	₺1.617,00	₺2.002,00		
DN50	140	₺2.310,00	₺2.310,00	₺2.849,00		
DN65	168	₺2.271,50	₺2.271,50	₺3.234,00		
DN80	219	₺3.465,00	₺3.465,00	₺4.312,00		
DN100	219	₺3.850,00	₺3.850,00	₺4.774,00		
DN125	273	₺5.005,00		₺6.352,50		
DN150	323	₺6.930,00		₺8.855,00		
DN200	400	₺9.625,00		₺11.935,00		
DN250	480	₺19.250,00		₺23.870,00		
DN300	600	₺25.795,00		₺34.650,00		

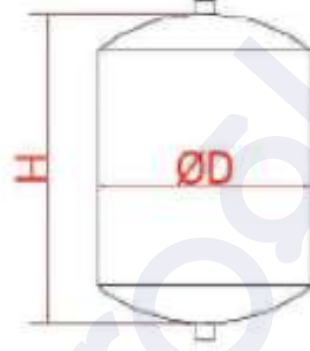

NÖTRALİZASYON ÜNİTESİ	
KAPASİTE	FİYAT LİSTESİ
350 KW	₺1.741,67
500 KW	₺1.741,67
750 KW	₺2.520,83
1000 KW	₺2.566,67
1500 KW	₺3.080,00
2000 KW	₺3.850,00
2500 KW	₺4.766,67
3000 KW	₺5.005,00
NÖTRALİZASYON ÜNİTESİ	
HACİM	
5 LT	₺330,00
10 LT	₺366,67

2025

ÜRÜN NO	ÜRÜN TANIMI	EBAT/DETAY	Miktarı	BİRİM	FİYATI
71016906	FRÄNKISCHE ff-therm multi Oksijen Bariyerli PE-Xa Boru	16 x 2 mm, 600 m kangal, turkuaz	600	m	€ 0,75
71900202-03	FRÄNKISCHE profitherm İzolasyon Plakası	MD - 1215 x 615 x 45mm	7,2	m ²	€ 4,42
71900111-01	FRÄNKISCHE profitherm Kenar İzolasyon Bandı	8x150 mm, Yapışkanlı	25	m	€ 0,56
72016630	FRÄNKISCHE ff-therm multi Kılıflı, Oksijen Bariyerli PE-Xa Boru	16 x 2 mm, 180 m kangal, kırmızı kılıflı	180	m	€ 1,35
72016631	FRÄNKISCHE ff-therm multi Kılıflı, Oksijen Bariyerli PE-Xa Boru	16 x 2 mm, 180 m kangal, mavi kılıflı	180	m	€ 1,35
71900601	FRÄNKISCHE ff-therm Kılıf Boru - Yerli	16/17 x 2 mm boru için, 100 m kangal	100	m	€ 0,53
71900116	FRÄNKISCHE profitherm Şap Katkı Maddesi	10 kg bidon	10	kg	€ 4,90
72816722	FRÄNKISCHE ff-therm Boru Bağlantı Rakoru	16x2,0 - 3/4" İD, nikelaj kaplama	10	Adet	€ 2,80
71900109	FRÄNKISCHE profitherm Sabitleyici Çengel	Yükseklik: 50mm	500	Adet	€ 0,04
71900102	FRÄNKISCHE profitherm Kavis Dirsek	16-17 mm	50	Adet	€ 0,85
79503002	FRÄNKISCHE profitherm Debi Göstergeli Çelik Kolektör	2 ağızlı	1	Adet	€ 106,25
79503003	FRÄNKISCHE profitherm Debi Göstergeli Çelik Kolektör	3 ağızlı	1	Adet	€ 128,13
79503004	FRÄNKISCHE profitherm Debi Göstergeli Çelik Kolektör	4 ağızlı	1	Adet	€ 150,00
79503005	FRÄNKISCHE profitherm Debi Göstergeli Çelik Kolektör	5 ağızlı	1	Adet	€ 163,63
79503006	FRÄNKISCHE profitherm Debi Göstergeli Çelik Kolektör	6 ağızlı	1	Adet	€ 186,78
79503007	FRÄNKISCHE profitherm Debi Göstergeli Çelik Kolektör	7 ağızlı	1	Adet	€ 208,73
79503008	FRÄNKISCHE profitherm Debi Göstergeli Çelik Kolektör	8 ağızlı	1	Adet	€ 233,70
79503009	FRÄNKISCHE profitherm Debi Göstergeli Çelik Kolektör	9 ağızlı	1	Adet	€ 254,19
79503010	FRÄNKISCHE profitherm Debi Göstergeli Çelik Kolektör	10 ağızlı	1	Adet	€ 276,75
79503011	FRÄNKISCHE profitherm Debi Göstergeli Çelik Kolektör	11 ağızlı	1	Adet	€ 303,13
79503012	FRÄNKISCHE profitherm Debi Göstergeli Çelik Kolektör	12 ağızlı	1	Adet	€ 321,10
79501230	FRÄNKISCHE profitherm Kesme Vanası	1" İD x 1" DD	2	Adet	€ 12,25
79506001	FRÄNKISCHE profitherm Siva Altı Kolektör Dolabı	Tip 1 - 600x700x110 mm	1	Adet	€ 90,00
79506002	FRÄNKISCHE profitherm Siva Altı Kolektör Dolabı	Tip 2 - 800x700x110 mm	1	Adet	€ 100,00
79506003	FRÄNKISCHE profitherm Siva Altı Kolektör Dolabı	Tip 3 - 1.000x700x110 mm	1	Adet	€ 112,00
79506004	FRÄNKISCHE profitherm Siva Altı Kolektör Dolabı	Tip 4 - 1.200x700x110 mm	1	Adet	€ 125,00
79506029	FRÄNKISCHE profitherm Dijital Oda Termostatı - Standart	230 V, Düz beyaz, Isıtma	1	Adet	€ 28,00
79506027	FRÄNKISCHE profitherm Aktüatör	230 V	1	Adet	€ 14,00
79506038	FRÄNKISCHE profitherm Terminal Kutusu, Standart	24/230 V, 6 kanallı, Isıtma	1	Adet	€ 55,00
79506082	FRÄNKISCHE profitherm İki Yollu Vana	DN 25, Kvs=0,25 - 2,6 m ³ /h	1	Adet	33,75

MAXİCONDENSE 110 – 150



%109 Verim ile MaxiCondense 110 – 150 Tabii ki! MaxiCondense 110 – 150 Duvar Tipi Yoğuşmalı Kazanlar yüksek kapasiteli ve premix efanjörü sayesinde maksimum verim ve tasarruf sağlar.

[DETAYLI BİLGİ](#)

MAXİCONDENSE 48 – 65



%94 Sezonal Verim ile MaxiCondense 48 – 65 Tabii ki! MaxiCondense 48 – 65 Duvar Tipi Yoğuşmalı Kazanlar müstakil binalar için yüksek verim ile maksimum ısıtma konforu sağlar.

[DETAYLI BİLGİ](#)

MAXİPREMİX 100 – 150 kW

Yeni



%108,3 verim ile MaxiPremix 100 – 150 kW Tabii ki! MaxiPremix 100 – 150 kW duvar tipi yoğuşmalı kazanlar üstün teknolojisi ile yüksek kapasite ihtiyaçlarına uygun çözüm sağlar.

[DETAYLI BİLGİ](#)



Türkiye'de
İ.S.K. ve TEK
25 mm flanşlı
maksimum ısıtma
ısıtma gücü!



DD DemirDöküm

2026

KOMBİLER	FİYAT
VİNTOMİX P 24 - YENİ	37.462,82
VİNTOMİX P 28 - YENİ	39.228,08
ADEMİX P 24 - YENİ	37.998,01
ADEMİX P 28 - YENİ	39.788,48
NİTROMİX P 24 (DG)	45.767,74
NİTROMİX P 28 (DG)	49.357,76
NİTROMİX P 35 (DG)	55.951,26
NİTROMİX İONİ P 24 - YENİ	50.298,57
NİTROMİX İONİ P 28 - YENİ	54.245,82
NİTROMİX İONİ P 34 - YENİ	61.490,95
İSOMİX P 35 (DG)	101.720,42
ŞOFBENLER	FİYAT
L 275 F 11 lt. Fanlı Hermetik (DG)	21.769,86
L 350 F 14 lt. Fanlı Hermetik (DG)	22.931,43
TERMOSİFONLAR	FİYAT
DT4 Titanium 50 B	11.004,93
DT4 Titanium 65 B	12.409,60
DT4 Titanium 80 B	13.933,89
DT4 Titanium Digital 50	12.132,77
DT4 Titanium Digital 65	13.650,22
DT4 Titanium Digital 80	15.307,79
KAZANLAR	FİYAT
MaxiPremix 100 Kw (Pompasız)	131.517,59
MaxiPremix 150 kW (Pompasız)	139.711,31
MaxiCondense 48	80.884,99
MaxiCondense 65	103.994,99
ISI POMPALARI	FİYAT
DemirDöküm MaxiAir R32 8 kW	181.147,93
DemirDöküm MaxiAir R32 10 kW	188.110,10
DemirDöküm MaxiAir R32 12 kW	215.263,86
DemirDöküm MaxiAir R32 16 kW	244.618,02
MaxiAir Plus Mono Isı Pompası 5 kW	240.037,23
MaxiAir Plus Mono Isı Pompası 8 kW	267.870,79
MaxiAir Plus Mono Isı Pompası 12 kW	326.185,86
MaxiAir Plus Mono Isı Pompası 15 kW	356.296,33
KLİMALAR	FİYAT
Kion Inverter 09	35.321,74
Kion Inverter 12	36.038,11
Kion Inverter 18	47.382,83
Kion Inverter 24	60.592,59
A7 Inverter 09	39.748,25
A7 Inverter 12	41.291,75
A7 Inverter 18	63.015,53
A7 Inverter 24	80.583,49
DEMİRDÖKÜM A420FI	124.730,63
ANİ SU ISITICISI	FİYAT
DDEI 18 B Anı Su Isıtıcısı	12.858,60
DDEI 21 B	13.707,34
DDEI 24 B	14.661,99
KOMBİ BACA AKSESUARLARI	FİYAT
ATIKGAZ BORU DONANIMI 75 cm (Ø60/100, Nitromix)	1.466,83
ATIKGAZ BORU DONANIMI 75 cm (Ø60/100, İsomix, Atrromix)	1.306,27
ATIKGAZ BORU DONANIMI 75 cm (Ø60/100, Atron Condense)	1.487,58
90° UZATMA DİRSEĞİ (Ø60/100, Nitromix, Atron Con.)	906,90
90° UZATMA DİRSEĞİ (Ø60/100, İsomix, Atrromix)	934,34
45° UZATMA DİRSEĞİ (Ø60/100, İsomix, Atrromix)	1.352,08
45° UZATMA DİRSEĞİ (Ø60/100, Nitromix, Atron Con.)	952,31
UZATMA BORUSU 50 cm (Ø60/100, Nitromix, Atron Con.)	1.996,87
UZATMA BORUSU 100 cm (Ø60/100, Nitromix, Atron Con.)	1.661,93
UZATMA BORUSU 150 cm (Ø60/100, Nitromix, Atron Con.)	698,27
UZATMA BORUSU 200 cm (Ø60/100, Nitromix, Atron Con.)	1.045,98
UZATMA BORUSU 50 cm (Ø60/100, İsomix, Atrromix)	1.662,60
UZATMA BORUSU 100 cm (Ø60/100, İsomix, Atrromix)	932,95
UZATMA BORUSU 200 cm (Ø60/100, İsomix, Atrromix)	653,07
ŞOFBEN BACA AKSESUARLARI	FİYAT
90° DİRSEK (Ø60/100, Şofben)	943,80
45° UZATMA DİRSEĞİ (Ø60/100, Şofben)	687,24
UZATMA BORUSU (Ø60/100, 500 mm, Şofben)	759,05
UZATMA BORUSU (Ø60/100, 1000 mm, Şofben)	1.327,03
UZATMA BORUSU (Ø60/100, 1500 mm, Şofben)	1.903,04
UZATMA BORUSU (Ø60/100, 2000 mm, Şofben)	2.236,08
ATIK GAZ DONANIMI 75 cm (Ø60/100, , Şofben)	1.233,04

DEMİR DÖKÜM PANEL 33 HATVE STANDART RADYATÖRLER					
PKKP	300	400	500	600	900
400	890,21	1.023,41	1.214,65	1.329,38	1.887,25
500	1.113,10	1.279,27	1.519,30	1.661,73	2.359,39
600	1.244,98	1.430,93	1.698,66	1.858,24	2.638,99
700	1.452,04	1.669,64	1.980,89	2.168,16	3.078,16
800	1.614,25	1.855,60	2.202,45	2.409,51	3.422,37
900	1.816,03	2.087,71	2.478,09	2.711,52	3.849,67
1000	1.895,16	2.177,39	2.584,91	2.828,90	4.015,85
1100	2.085,08	2.395,00	2.843,40	3.111,13	4.418,09
1200	2.273,67	2.613,93	3.101,90	3.393,36	4.819,02
1300	2.389,73	2.745,81	3.260,16	3.566,13	5.064,32
1400	2.573,04	2.956,82	3.510,73	3.840,44	5.453,38
1500	2.757,68	3.169,16	3.761,31	4.114,76	5.843,75
1600	2.910,66	3.344,56	3.971,01	4.344,24	6.168,18
1800	3.274,66	3.762,63	4.466,89	4.887,60	6.939,70
2000	3.638,66	4.180,70	4.962,77	5.429,64	7.711,22
2200	3.918,25	4.503,82	5.345,23	5.849,03	8.306,01
2400	4.274,34	4.912,65	5.831,88	6.380,52	9.060,38
2600	4.631,74	5.322,81	6.317,21	6.912,00	.
2800	4.987,83	5.731,65	6.803,86	7.443,49	.
3000	5.343,91	6.141,81	7.289,19	7.976,30	11.326,14

DEMİR DÖKÜM 33 HATVE KOMPAKT VENTİLLİ RADYATÖRLER					
PKKP	300	400	500	600	900
400	1.417,75	.	1.742,18	1.856,92	2.414,78
500	1.640,63	1.806,80	2.046,83	2.189,26	2.886,93
600	1.772,51	1.958,47	2.226,19	2.385,77	3.166,52
700	1.979,57	2.197,18	2.508,42	2.695,70	3.605,69
800	2.141,79	2.383,13	2.729,98	2.937,04	3.949,91
900	2.343,57	2.615,25	3.005,62	3.239,05	4.377,21
1000	2.422,70	2.704,93	3.112,45	3.356,43	4.543,38
1100	.	2.922,53	3.370,94	3.638,66	4.945,62
1200	2.801,20	3.141,46	3.629,43	3.920,89	5.346,55
1300	.	3.273,34	3.787,69	4.093,66	5.591,85
1400	3.100,58	3.484,36	4.038,27	4.367,98	5.980,91
1500	.	.	4.288,85	4.642,29	6.371,28
1600	3.438,20	3.872,09	4.498,54	4.871,77	6.695,72
1800	3.802,20	4.290,16	4.994,42	5.415,13	7.467,23
2000	4.166,19	4.708,23	5.490,30	5.957,17	8.238,75
2200	4.445,79	5.031,35	5.872,76	6.376,56	.
2400	4.801,87	5.440,19	6.359,41	6.908,05	.
2600	5.159,28	5.850,34	6.844,74	.	.
2800	5.515,36	.	7.331,39	.	.
3000	5.871,45	.	7.816,72	.	.

DEMİR DÖKÜM PLUS PANEL RADYATÖRLER					
PKKP	300	400	500	600	900
400	931,70	1.069,87	1.270,16	1.390,58	1.973,69
500	1.163,68	1.337,34	1.588,33	1.737,91	2.466,79
600	1.301,85	1.495,79	1.775,94	1.943,26	2.759,61
700	1.518,61	1.745,51	2.071,29	2.266,51	3.218,49
800	1.688,47	1.940,73	2.303,27	2.520,03	3.578,49
900	1.898,90	2.182,84	2.591,02	2.834,40	4.024,70
1000	1.981,29	2.276,65	2.702,57	2.957,36	4.199,63
1100	2.179,04	2.504,82	2.973,84	3.252,72	4.619,21
1200	2.378,06	2.732,99	3.243,84	3.549,34	5.038,79
1300	2.498,48	2.871,16	3.408,63	3.729,34	5.294,85
1400	2.691,16	3.093,00	3.671,03	4.015,82	5.703,03
1500	2.882,57	3.313,56	3.933,43	4.302,31	6.109,93
1600	3.043,56	3.497,37	4.151,46	4.541,89	6.450,92
1800	3.423,85	3.934,70	4.671,18	5.109,78	7.257,13
2000	3.804,13	4.372,03	5.189,64	5.677,68	8.063,34
2200	4.096,95	4.709,21	5.590,21	6.116,27	8.684,47
2400	4.469,63	5.137,67	6.098,53	6.671,49	9.474,20
2600	4.842,31	5.564,86	.	7.227,98	10.263,93
2800	5.214,99	5.993,31	7.113,89	7.783,19	.
3000	5.587,67	6.421,77	7.622,21	8.339,68	.



POMPA VE HİDROFOR

FIYAT LİSTESİ



1986'dan beri

Serdaroğlu®

TESİSAT TEKNİK MALZEME SAN. TİC. A.Ş.

CALIO

SIRKÜLASYON POMPALARI

CALIO|CALIO SI



 KSB

01.07.2025

CALIO SERİSİ

CALIO SI SERİSİ	
MALZEME ADI	FİYAT LİSTESİ
CALIO SI 15-75 DCS	€ 132,89
CALIO SI THERM 25-70-180	€ 365,44
CALIO SI THERM 25-70-180 BC	€ 347,56
CALIO SI 25-75-130	€ 144,39
CALIO SI 25-80-130	€ 144,39
CALIO SI 25-80-180	€ 150,78
CALIO SI 25-95-180	€ 227,44
CALIO SI 25-75-180 SOLAR	€ 150,78
CALIO SI ECOMATCH PP 25-75-130	€ 141,83
CALIO SI ECOMATCH CP 25-70-180	€ 148,22
CALIO SI DUAL 25-80-130	€ 157,17
CALIO SI DUAL 25-80-180	€ 163,56
CALIO SI THERM DUAL 25-80-180	€ 365,44
CALIO SI HP MINI 25-130 PWM BC	€ 356,50
CALIO SI HP MINI 25-95-180 PWM-BC	€ 369,28
CALIO SI HP MINI 25-130 PWM	€ 374,39
CALIO SI HP MINI 25-95-180	€ 385,89
CALIO SI HP 25-80 150W PWM	€ 401,22
CALIO SI HP 25-80 150W PWM	€ 424,22

CALIO SERİSİ	
MALZEME ADI	FİYAT LİSTESİ
Calio Pro 25-100 220W	€ 565,38
Calio Pro 30-100 220W	€ 567,84
Calio Pro 32-100 220W	€ 616,30
Calio Pro 40-90 220W	€ 637,20
Calio Pro 50-90 220W	€ 698,08
Calio Pro 30-120 400 W	€ 623,96
Calio Pro 32-120 400W	€ 680,50
Calio Pro 40-80 400W	€ 707,64
Calio Pro 40-100 400W	€ 707,64
Calio Pro 50-60 400W	€ 713,68
Calio Pro 50-80 400W	€ 713,68
Calio Pro 65-60 400W	€ 799,82
Calio 040-120 800W	€ 1.485,88
Calio 040-180 800W	€ 1.485,88
Calio 050-100 800W	€ 1.494,92
Calio 050-120 800W	€ 1.494,92
Calio 050-150 800W	€ 1.494,92
Calio 050-180 800W	€ 1.494,92
Calio 065-120 800W	€ 1.571,82
Calio 080-080 800W	€ 1.617,74
Calio 080-080 800W	€ 1.618,96

01.07.2025

CALIO SEÇİM EĞRİLERİ

CALIO PRO PLUS KARAKTERİSTİK EĞRİ

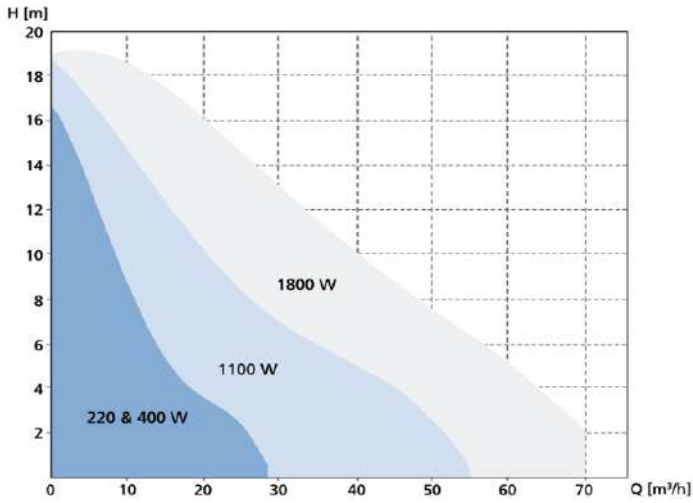

CALIO Z KARAKTERİSTİK EĞRİ

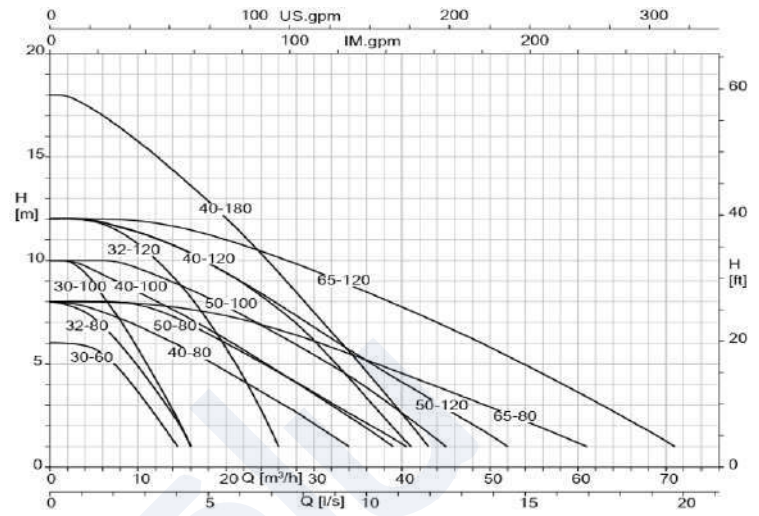

CALIO PRO Z

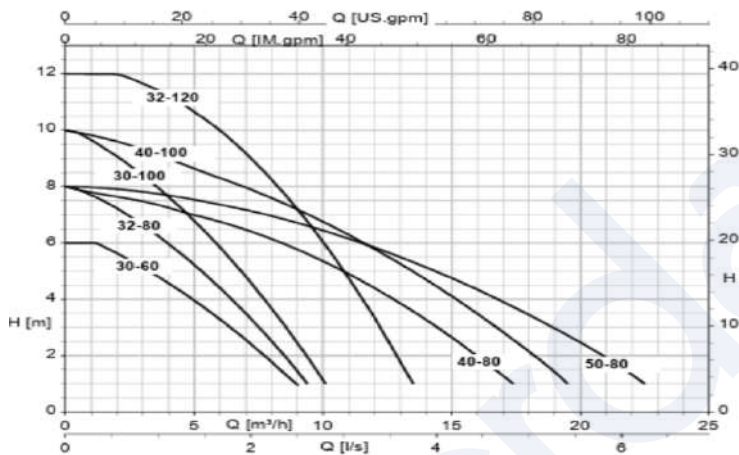

CALIO PRO

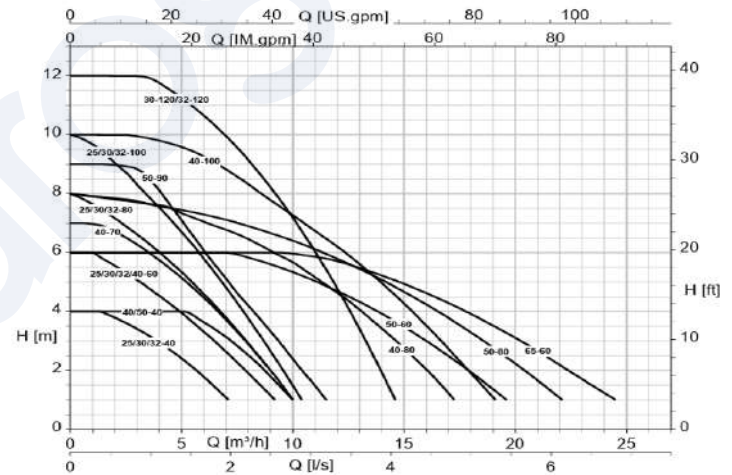

CALIO THERM PRO

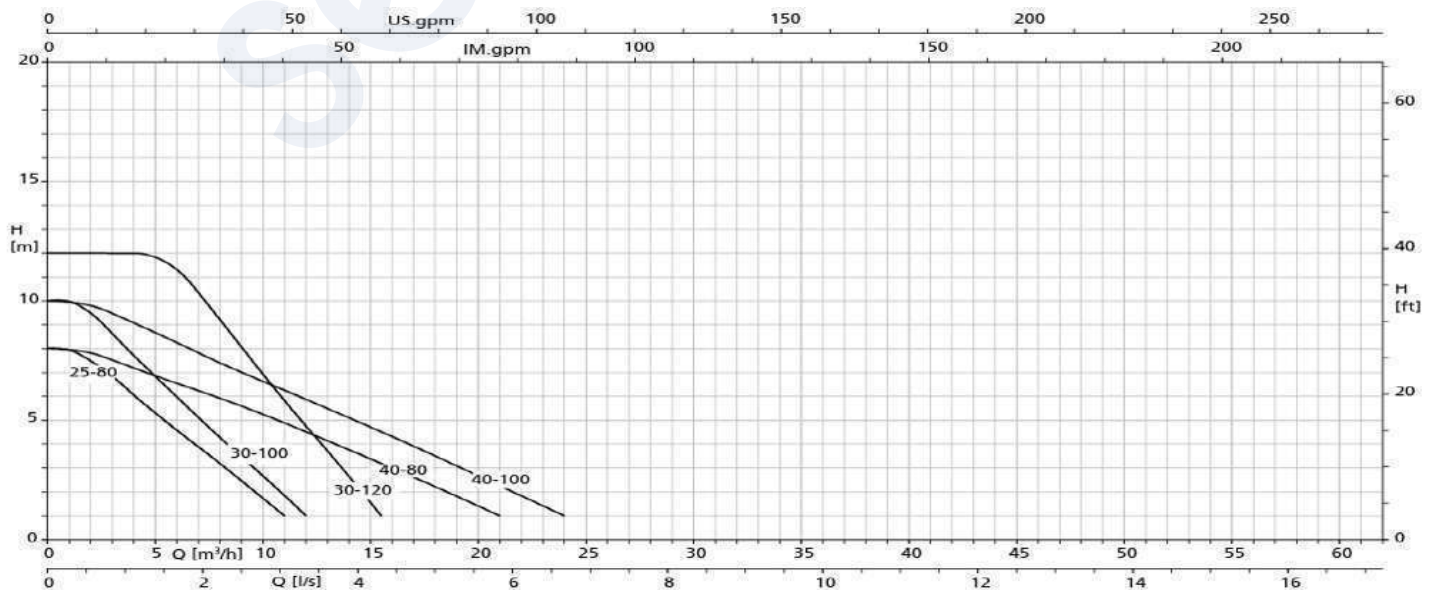

01.07.2025

HİDROFORLAR

1MULTI-9NVP10 1,5 KW 1 POMPALI HİDROFOR	€ 746,67
1MULTI-9NVP12 2,2 KW 1 POMPALI HİDROFOR	€ 770,00
1MULTI-9NVP14 3 KW 1 POMPALI HİDROFOR	€ 828,33
1MULTI-10NVP04 1,5 KW 1 POMPALI HİDROFOR	€ 793,33
1MULTI-10NVP06 2,2 KW 1 POMPALI HİDROFOR	€ 828,33
1MULTI-10NVP08 3 KW 1 POMPALI HİDROFOR	€ 863,33
1MULTI-10NVP10 4 KW 1 POMPALI HİDROFOR	€ 1.003,33
1MULTI-10NVP12 5,5 KW 1 POMPALI HİDROFOR	€ 1.260,00
1MULTI-1 15NVP03 3 KW 1 POMPALI HİDRAFOR	€ 863,33
1MULTI-1 15NVP04 4 KW 1 POMPALI HİDRAFOR	€ 933,33
1MULTI-1 15NVP05 4 KW 1 POMPALI HİDRAFOR	€ 1.003,33
1MULTI-1 15NVP06 5,5 KW 1 POMPALI HİDRAFOR	€ 1.096,67
1MULTI-1 15NVP07 5,5 KW 1 POMPALI HİDRAFOR	€ 1.166,67
1MULTI-1 15NVP08 7,5 KW 1 POMPALI HİDRAFOR	€ 1.353,33
1MULTI-1 15NVP09 11 KW 1 POMPALI HİDRAFOR	€ 1.645,00

ÜRÜN ADI	FİYAT
3MULTI-9NVP10 3x1,5 KW 3 POMPALI HİDROFOR	€ 1.925,00
3MULTI-9NVP12 3x2,2 KW 3 POMPALI HİDROFOR	€ 2.030,00
3MULTI-9NVP143x3 KW 3 POMPALI HİDROFOR	€ 2.205,00
3MULTI-10NVP04 2X1,5 KW 1 POMPALI HİDROFOR	€ 1.960,00
3MULTI-10NVP06 3X2,2 KW 1 POMPALI HİDROFOR	€ 2.076,67
3MULTI-10NVP08 3X3 KW 1 POMPALI HİDROFOR	€ 2.263,33
3MULTI-10NVP10 3X4 KW 1 POMPALI HİDROFOR	€ 2.660,00
3MULTI-10NVP12 3X5,5 KW 1 POMPALI HİDROFOR	€ 3.010,00
3MULTI-1 15NVP03 3X3 KW 3 POMPALI HİDROFOR	€ 2.298,33
3MULTI-1 15NVP04 3X4 KW 3 POMPALI HİDROFOR	€ 2.508,33
3MULTI-1 15NVP05 3X4 KW 3 POMPALI HİDROFOR	€ 2.671,67
3MULTI-1 15NVP06 3X5,5 KW 3 POMPALI HİDROFOR	€ 3.080,00
3MULTI-1 15NVP07 3X5,5 KW 3 POMPALI HİDROFOR	€ 3.336,67
3MULTI-1 15NVP08 3X7,5 KW 3 POMPALI HİDROFOR	€ 3.640,00
3MULTI-1 15NVP10 3X11 KW 3 POMPALI HİDROFOR	€ 4.340,00

ÜRÜN ADI	FİYAT
2MULTI-F 9NVP10 2X1,5 KW 2 POMPALI HİDROFOR	€ 2.240,00
2MULTI-F 9NVP12 2X2,2 KW 2 POMPALI HİDROFOR	€ 2.520,00
2MULTI-F 9NVP14 2X3 KW 2 POMPALI HİDROFOR	€ 2.846,67
2MULTI-F 10NVP04 2X1,5 KW 1 POMPALI HİDROFOR	€ 2.450,00
2MULTI-F 10NVP06 2X2,2 KW 1 POMPALI HİDROFOR	€ 2.636,67
2MULTI-F 10NVP08 2X3 KW 1 POMPALI HİDROFOR	€ 2.893,33
2MULTI-F 10NVP10 2X4 KW 1 POMPALI HİDROFOR	€ 3.243,33
2MULTI-F 10NVP12 2X5,5 KW 1 POMPALI HİDROFOR	€ 3.756,67
2MULTI-F 15NVP03 2X3 KW 2 POMPALI HİDROFOR	€ 2.940,00
2MULTI-F 15NVP04 2X4 KW 2 POMPALI HİDROFOR	€ 3.290,00
2MULTI-F 15NVP05 2X4 KW 2 POMPALI HİDROFOR	€ 3.360,00
2MULTI-F 15NVP06 2X5,5 KW 2 POMPALI HİDROFOR	€ 3.640,00
2MULTI-F 15NVP07 2X5,5 KW 2 POMPALI HİDROFOR	€ 3.710,00
2MULTI-F 15NVP08 2X7,5 KW 2 POMPALI HİDROFOR	€ 4.060,00
2MULTI-F 15NVP10 2X11 KW 2 POMPALI HİDROFOR	€ 4.421,67
2MULTI-F 15NVP07 2X5,5 KW 2 POMPALI HİDROFOR	€ 3.710,00
2MULTI-F 15NVP08 2X7,5 KW 2 POMPALI HİDROFOR	€ 4.060,00
2MULTI-F 15NVP10 2X11 KW 2 POMPALI HİDROFOR	€ 4.421,67

ÜRÜN ADI	FİYAT
2MULTI-9NVP10 2X1,5 KW 2 POMPALI HİDROFOR	€ 1.283,33
2MULTI-9NVP12 2X2,2 KW 2 POMPALI HİDROFOR	€ 1.353,33
2MULTI-9NVP14 2X3 KW 2 POMPALI HİDROFOR	€ 1.446,67
2MULTI-10NVP04 2X1,5 KW 1 POMPALI HİDROFOR	€ 1.283,33
2MULTI-10NVP06 2X2,2 KW 1 POMPALI HİDROFOR	€ 1.353,33
2MULTI-10NVP08 2X3 KW 1 POMPALI HİDROFOR	€ 1.446,67
2MULTI-10NVP10 2X4 KW 1 POMPALI HİDROFOR	€ 1.773,33
2MULTI-10NVP12 2X5,5 KW 1 POMPALI HİDROFOR	€ 2.123,33
2MULTI-1 15NVP03 2X3 KW 2 POMPALI HİDROFOR	€ 1.470,00
2MULTI-1 15NVP04 2X4 KW 2 POMPALI HİDROFOR	€ 1.750,00
2MULTI-1 15NVP05 2X4 KW 2 POMPALI HİDROFOR	€ 1.820,00
2MULTI-1 15NVP06 2X5,5 KW 2 POMPALI HİDROFOR	€ 1.960,00
2MULTI-1 15NVP07 2X5,5 KW 2 POMPALI HİDROFOR	€ 2.146,67
2MULTI-1 15NVP08 2X7,5 KW 2 POMPALI HİDROFOR	€ 2.240,00
2MULTI-1 15NVP10 2X11 KW 2 POMPALI HİDROFOR	€ 2.870,00

ÜRÜN ADI	FİYAT
1MULTI-F 9NVP10 1,5 KW 1 POMPALI HİDROFOR	€ 1.330,00
1MULTI-F 9NVP12 2,2 KW 1 POMPALI HİDROFOR	€ 1.470,00
1MULTI-F 9NVP14 3 KW 1 POMPALI HİDROFOR	€ 1.598,33
1MULTI-F 10NVP04 1,5 KW 1 POMPALI HİDROFOR	€ 1.423,33
1MULTI-F 10NVP06 2,2 KW 1 POMPALI HİDROFOR	€ 1.493,33
1MULTI-F 10NVP08 3 KW 1 POMPALI HİDROFOR	€ 1.656,67
1MULTI-F 10NVP10 4 KW 1 POMPALI HİDROFOR	€ 1.890,00
1MULTI-F 10NVP12 5,5 KW 1 POMPALI HİDROFOR	€ 2.146,67
1MULTI-F 15NVP03 3 KW 1 POMPALI HİDRAFOR	€ 1.656,67
1MULTI-F 15NVP04 4 KW 1 POMPALI HİDRAFOR	€ 1.890,00
1MULTI-F 15NVP05 4 KW 1 POMPALI HİDRAFOR	€ 1.936,67
1MULTI-F 15NVP06 5,5 KW 1 POMPALI HİDRAFOR	€ 2.263,33
1MULTI-F 15NVP07 5,5 KW 1 POMPALI HİDRAFOR	€ 2.310,00
1MULTI-F 15NVP08 7,5 KW 1 POMPALI HİDRAFOR	€ 2.671,67
1MULTI-F 15NVP09 11 KW 1 POMPALI HİDRAFOR	€ 2.870,00

ÜRÜN ADI	FİYAT
3MULTI-F 9NVP10 3x1,5 KW 3 POMPALI HİDROFOR	€ 3.290,00
3MULTI-F 9NVP12 3x2,2 KW 3 POMPALI HİDROFOR	€ 3.476,67
3MULTI-F 9NVP143x3 KW 3 POMPALI HİDROFOR	€ 3.686,67
3MULTI-F 10NVP04 2X1,5 KW 1 POMPALI HİDROFOR	€ 2.660,00
3MULTI-F 10NVP06 3X2,2 KW 1 POMPALI HİDROFOR	€ 3.570,00
3MULTI-F 10NVP08 3X3 KW 1 POMPALI HİDROFOR	€ 3.873,33
3MULTI-F 10NVP10 3X4 KW 1 POMPALI HİDROFOR	€ 4.176,67
3MULTI-F 10NVP12 3X5,5 KW 1 POMPALI HİDROFOR	€ 4.806,67
3MULTI-F 15NVP03 3X3 KW 3 POMPALI HİDROFOR	€ 3.920,00
3MULTI-F 15NVP04 3X4 KW 3 POMPALI HİDROFOR	€ 4.246,67
3MULTI-F 15NVP05 3X4 KW 3 POMPALI HİDROFOR	€ 4.340,00
3MULTI-F 15NVP06 3X5,5 KW 3 POMPALI HİDROFOR	€ 4.643,33
3MULTI-F 15NVP07 3X5,5 KW 3 POMPALI HİDROFOR	€ 4.736,67
3MULTI-F 15NVP08 3X7,5 KW 3 POMPALI HİDROFOR	€ 5.203,33
3MULTI-F 15NVP10 3X11 KW 3 POMPALI HİDROFOR	€ 5.693,33

01.04.2023



01.04.2023

Monofaze Motorlu

Pompa Tipi	Motor Gücü (kW)	Tank Hacmi	Kat Sayısı	Daire Sayısı	Liste Satış Fiyatı
TH SBM 80/5	0.75	24	1-3	1-10	771 €
		50			794 €
TH SBM 80/6	0.75	24	3-5	1-10	779 €
		50			802 €
TH SBM 80/7	1.1	24	5-7	1-10	801 €
		50			823 €
TH SBM 80/8	1.1	24	7-10	1-10	809 €
		50			832 €
TH SBM 80/9	1.1	24	10-13	1-10	819 €
		50			841 €

Trifaze Motorlu

Pompa Tipi	Motor Gücü (kW)	Tank Hacmi	Kat Sayısı	Daire Sayısı	Liste Satış Fiyatı
TH SBT 80/5	0.75	24	1-3	1-10	769 €
		50			792 €
TH SBT 80/6	0.75	24	3-5	1-10	787 €
		50			809 €
TH SBT 80/7	1.1	24	5-7	1-10	813 €
		50			835 €
TH SBT 80/8	1.1	24	7-10	1-10	821 €
		50			843 €
TH SBT 80/9	1.1	24	10-13	1-10	825 €
		50			847 €
TH SBT 80/10	1.5	24	13-16	1-10	830 €
		50			850 €
TH SBT 80/11	1.5	24	16-19	1-10	835 €
		50			857 €

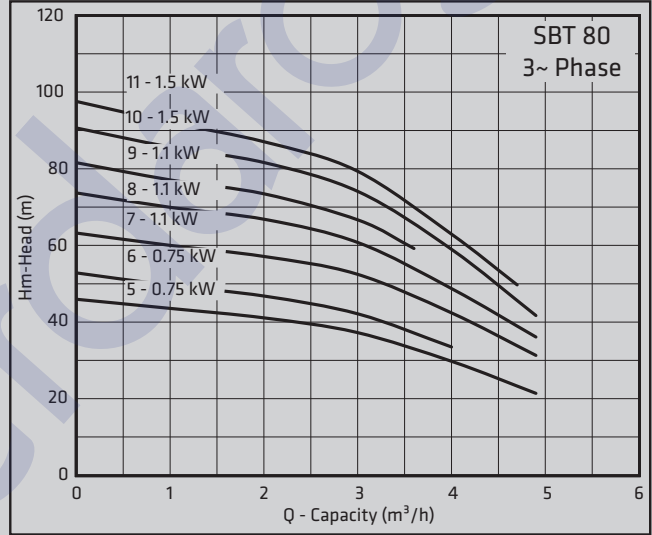
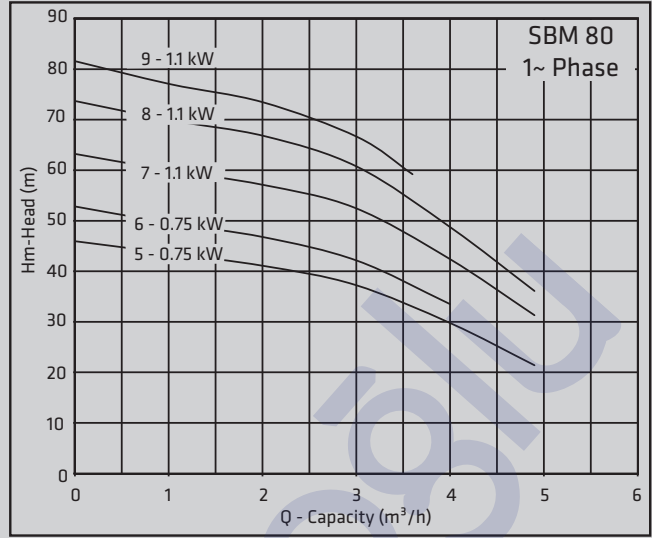

SBT 80/10-50

- Tank Hacmi
- Kademe Sayısı
- Motor Yapı Büyüklüğü
- T= Trifaze M= Monofaze
- Pompanın İsmi

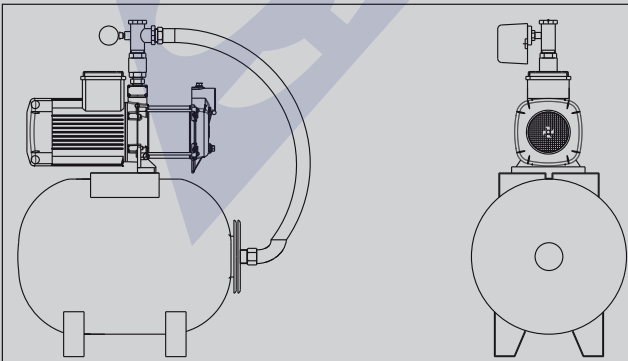

Yatık Tanklı Hidroforlarda;

Değiştirilebilen tip hijyenik membranlı denge tankı.
Elektrik panosu.
3m kablolu susuz çalışmayı önleyici seviye flatörü.
Sessiz tip çek valf.
5 yollu bağlantı parçası.
Manometre.
Basınç şalteri
Esnek bağlantı hortumu teslimat kapsamındadır.

01.04.2023

Monofaze Motorlu

Pompa Tipi	Motor Gücü (kW)	Tank Hacmi	Kat Sayısı	Daire Sayısı	Liste Satış Fiyatı
TH SBM 90/4	1.5	50	1-6	1-18	906 €
		80			962 €
TH SBM 90/5	2.2	50	6-9	1-18	936 €
		80			992 €
TH SBM 90/6	2.2	50	9-14	1-18	948 €
		80			1.004 €

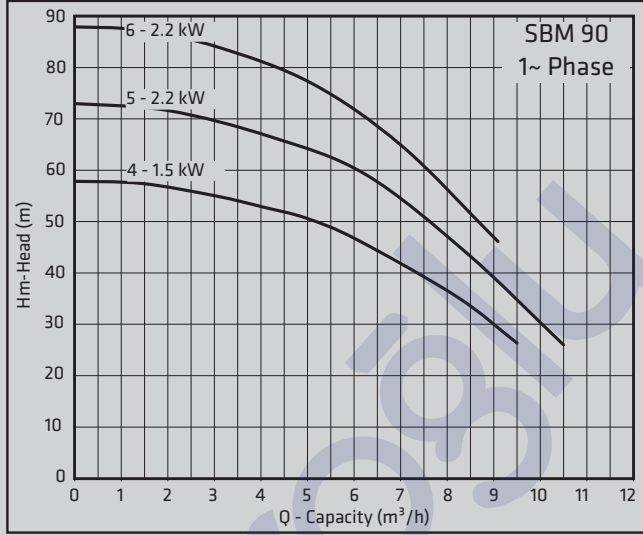

Trifaze Motorlu

Pompa Tipi	Motor Gücü (kW)	Tank Hacmi	Kat Sayısı	Daire Sayısı	Liste Satış Fiyatı
TH SBT 90/4	1.5	50	1-6	1-18	846 €
		80			903 €
TH SBT 90/5	2.2	50	6-9	1-18	912 €
		80			968 €
TH SBT 90/6	2.2	50	9-14	1-18	927 €
		80			984 €
TH SBT 90/7	3	50	14-18	1-18	968 €
		80			1.025 €

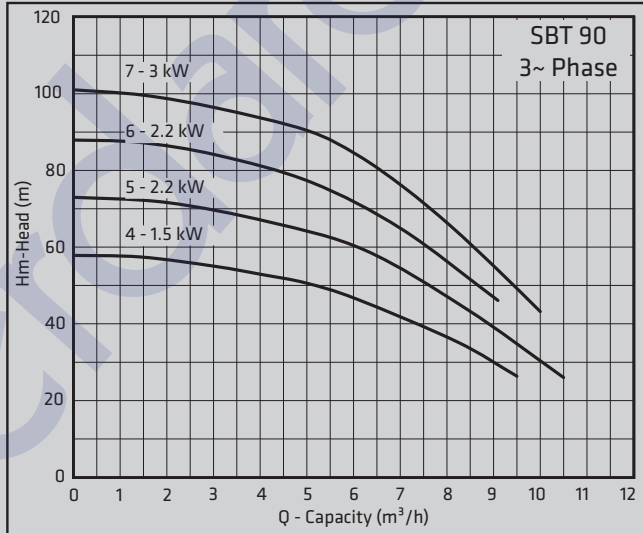

Pompa Tipi	Motor Gücü (kW)	Tank Hacmi	Kat Sayısı	Daire Sayısı	Liste Satış Fiyatı
TH SBT 100/3	3	80	1-6	1-40	1.079 €
		100			1.084 €
TH SBT 100/4	4	80	6-12	1-40	1.136 €
		100			1.141 €
TH SBT 100/5	5.5	80	12-18	1-40	1.188 €
		100			1.191 €

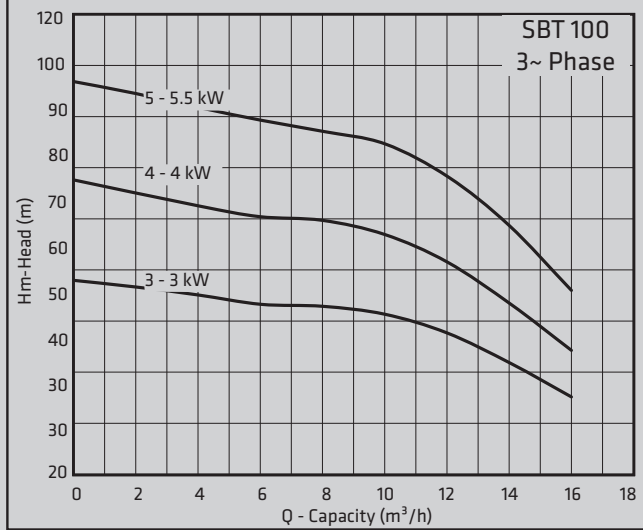

01.04.2023

Dikey Pompalı Tam Otomatik Paket Hidroforlar Kat ve Daire Sayılarına Göre Hidrofor Seçimi Tank ve Montaj Hortumu Hariç Komple Fiyat Listesi

Kat Sayısı	Daire Sayısı	Debi (m ³ /h)	Pompa Tipi	Liste Satış Fiyatı
	1-12	3.5	TH 1xSBT - V 80/5	724 €
	10-20	8	TH 1xSBT - V 90/4	802 €
4 Kat 30-45 (mSS)	20-40	15	TH 1xSBT - V 100/3	968 €
	40-60	18	TH 2xSBT - V 90/5	1.724 €
	60-80	30	TH 2x SBT - V 100/3	1.950 €
	80-100	30	TH 2x SBT - V 100/3	1.950 €

Kat Sayısı	Daire Sayısı	Debi (m ³ /h)	Hidrofor Tipi	Liste Satış Fiyatı
	1-12	3.6	TH 1xSBT - V 80/10	785 €
	10-20	6.5	TH 1xSBT - V 90/6	889 €
14 Kat 60-75 (mSS)	20-40	11	TH 1xSBT - V 100/4	1.025 €
	40-60	16	TH 2xSBT - V 90/7	1.845 €
	60-80	22	TH 2x SBT - V 100/4	2.063 €
	80-100	28	TH 2x SBT - V 100/5	2.163 €

Kat Sayısı	Daire Sayısı	Debi (m ³ /h)	Pompa Tipi	Liste Satış Fiyatı
	1-12	3.5	TH 1xSBT - V 80/6	742 €
	10-20	7.5	TH 1xSBT - V 90/4	802 €
6 Kat 30-50 (mSS)	20-40	14	TH 1xSBT - V 100/3	968 €
	40-60	18	TH 2xSBT - V 90/5	1.724 €
	60-80	28	TH 2x SBT - V 100/3	1.950 €
	80-100	28	TH 2x SBT - V 100/3	1.950 €

Kat Sayısı	Daire Sayısı	Debi (m ³ /h)	Hidrofor Tipi	Liste Satış Fiyatı
	1-12	3.6	TH 1xSBT - V 80/11	790 €
	10-20	7.5	TH 1xSBT - V 90/7	931 €
16 Kat 65-80 (mSS)	20-40	13.5	TH 1xSBT - V 100/5	1.074 €
	40-60	27	TH 2xSBT - V 100/5	2.163 €
	60-80	27	TH 2x SBT - V 100/5	2.163 €
	80-100	27	TH 2x SBT - V 100/5	2.163 €

Kat Sayısı	Daire Sayısı	Debi (m ³ /h)	Pompa Tipi	Liste Satış Fiyatı
	1-12	3.4	TH 1xSBT - V 80/7	767 €
	10-20	7.5	TH 1xSBT - V 90/5	870 €
8 Kat 45-60 (mSS)	20-40	14	TH 1xSBT - V 100/4	1.025 €
	40-60	16.5	TH 2xSBT - V 90/6	1.760 €
	60-80	28	TH 2x SBT - V 100/4	2.063 €
	80-100	28	TH 2x SBT - V 100/4	2.063 €

Kat Sayısı	Daire Sayısı	Debi (m ³ /h)	Hidrofor Tipi	Liste Satış Fiyatı
	1-12	3.5	TH 1xSBT - V 80/12	794 €
	10-20	6.4	TH 1xSBT - V 90/7	931 €
18 Kat 75-90 (mSS)	20-40	11.5	TH 1xSBT - V 100/5	1.074 €
	40-60	13	TH 1xSBT - V 100/6	1.094 €
	60-80	23	TH 2x SBT - V 100/5	2.163 €
	80-100	26	TH 2x SBT - V 100/6	2.201 €

Kat Sayısı	Daire Sayısı	Debi (m ³ /h)	Pompa Tipi	Liste Satış Fiyatı
	1-12	3.5	TH 1xSBT - V 80/8	775 €
	10-20	7.6	TH 1xSBT - V 90/6	889 €
10 Kat 50-65 (mSS)	20-40	13	TH 1xSBT - V 100/4	1.025 €
	40-60	16.5	TH 2xSBT - V 90/7	1.845 €
	60-80	26	TH 2x SBT - V 100/4	2.063 €
	80-100	26	TH 2x SBT - V 100/4	2.063 €

Kat Sayısı	Daire Sayısı	Debi (m ³ /h)	Hidrofor Tipi	Liste Satış Fiyatı
	1-12	3.3	TH 1xSBT - V 80/12	794 €
	10-20	6.7	TH 1xSBT - V 90/8	944 €
20 Kat 80-95 (mSS)	20-40	12.5	TH 1xSBT - V 100/6	1.094 €
	40-60	21	TH 2xSBT - V 100/5	2.163 €
	60-80	21	TH 2xSBT - V 100/5	2.163 €
	80-100	25	TH 2x SBT - V 100/6	2.201 €

Kat Sayısı	Daire Sayısı	Debi (m ³ /h)	Pompa Tipi	Liste Satış Fiyatı
	1-12	3.5	TH 1xSBT - V 80/9	782 €
	10-20	7.2	TH 1xSBT - V 90/6	889 €
12 Kat 55-70 (mSS)	20-40	14.4	TH 2xSBT - V 90/6	1.760 €
	40-60	16.5	TH 2xSBT - V 90/7	1.845 €
	60-80	26	TH 2x SBT - V 100/4	2.063 €
	80-100	26	TH 2x SBT - V 100/4	2.063 €

Kat Sayısı	Daire Sayısı	Debi (m ³ /h)	Hidrofor Tipi	Liste Satış Fiyatı
	1-12	3	TH 1xSBT - V 80/12	794 €
	10-20	6.6	TH 1xSBT - V 90/8	944 €
22 Kat 85-100 (mSS)	20-40	11.5	TH 1xSBT - V 100/6	1.094 €
	40-60	23	TH 2xSBT - V 100/6	2.201 €
	60-80	23	TH 2x SBT - V 100/6	2.201 €
	80-100	25	TH 2x SBT - V 100/7	2.239 €

Dikey Pompalı Tam Otomatik Paket Hidroforlar

Monofaze

Hidrofor Tipi	Motor		Liste Satış Fiyatı
	kW	rpm	
TH 1xSBM-V 80/5	0.75	2900	755 €
TH 2xSBM-V 80/5	0.75	2900	1.467 €
TH 3xSBM-V 80/5	0.75	2900	2.076 €
TH 1xSBM-V 80/6	0.75	2900	764 €
TH 2xSBM-V 80/6	0.75	2900	1.486 €
TH 3xSBM-V 80/6	0.75	2900	2.105 €
TH 1xSBM-V 80/7	1.1	2900	787 €
TH 2xSBM-V 80/7	1.1	2900	1.533 €
TH 3xSBM-V 80/7	1.1	2900	2.175 €
TH 1xSBM-V 80/8	1.1	2900	796 €
TH 2xSBM-V 80/8	1.1	2900	1.549 €
TH 3xSBM-V 80/8	1.1	2900	2.199 €
TH 1xSBM-V 80/9	1.1	2900	807 €
TH 2xSBM-V 80/9	1.1	2900	1.571 €
TH 3xSBM-V 80/9	1.1	2900	2.233 €

TH 1xSBM-V 90/4	1.5	2900	861 €
TH 2xSBM-V 90/4	1.5	2900	1.706 €
TH 3xSBM-V 90/4	1.5	2900	2.437 €
TH 1xSBM-V 90/5	2.2	2900	893 €
TH 2xSBM-V 90/5	2.2	2900	1.769 €
TH 3xSBM-V 90/5	2.2	2900	2.535 €
TH 1xSBM-V 90/6	2.2	2900	908 €
TH 2xSBM-V 90/6	2.2	2900	1.798 €
TH 3xSBM-V 90/6	2.2	2900	2.579 €

Tank ve bağlantı hortumu hariç komple fiyattır.

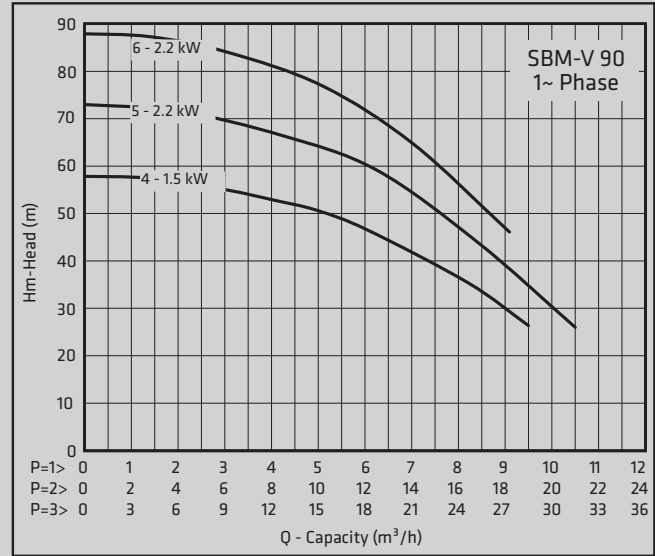
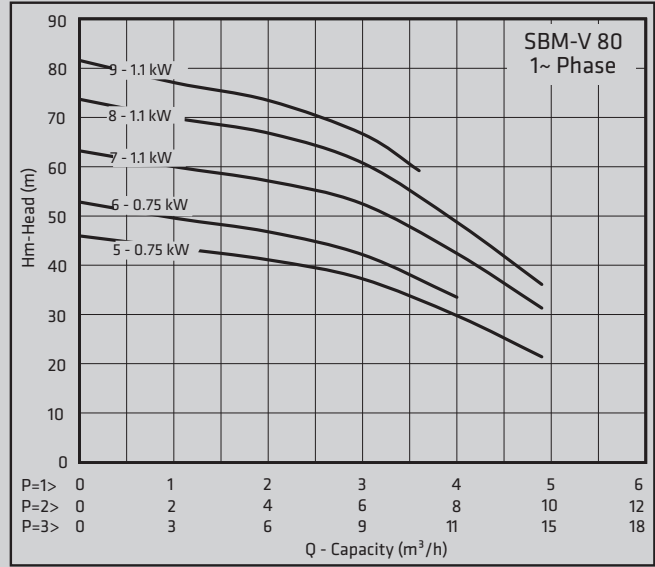

01.04.2023

Dikey Pompalı Tam Otomatik Paket Hidroforlar

Monofaze

Hidrofor Tipi	Motor		Liste Satış Fiyatı
	kW	rpm	
TH 1xSBM-V 80/5	0.75	2900	755 €
TH 2xSBM-V 80/5	0.75	2900	1.467 €
TH 3xSBM-V 80/5	0.75	2900	2.076 €
TH 1xSBM-V 80/6	0.75	2900	764 €
TH 2xSBM-V 80/6	0.75	2900	1.486 €
TH 3xSBM-V 80/6	0.75	2900	2.105 €
TH 1xSBM-V 80/7	1.1	2900	787 €
TH 2xSBM-V 80/7	1.1	2900	1.533 €
TH 3xSBM-V 80/7	1.1	2900	2.175 €
TH 1xSBM-V 80/8	1.1	2900	796 €
TH 2xSBM-V 80/8	1.1	2900	1.549 €
TH 3xSBM-V 80/8	1.1	2900	2.199 €
TH 1xSBM-V 80/9	1.1	2900	807 €
TH 2xSBM-V 80/9	1.1	2900	1.571 €
TH 3xSBM-V 80/9	1.1	2900	2.233 €

TH 1xSBM-V 90/4	1.5	2900	861 €
TH 2xSBM-V 90/4	1.5	2900	1.706 €
TH 3xSBM-V 90/4	1.5	2900	2.437 €
TH 1xSBM-V 90/5	2.2	2900	893 €
TH 2xSBM-V 90/5	2.2	2900	1.769 €
TH 3xSBM-V 90/5	2.2	2900	2.535 €
TH 1xSBM-V 90/6	2.2	2900	908 €
TH 2xSBM-V 90/6	2.2	2900	1.798 €
TH 3xSBM-V 90/6	2.2	2900	2.579 €

Tank ve bağlantı hortumu hariç komple fiyattır.

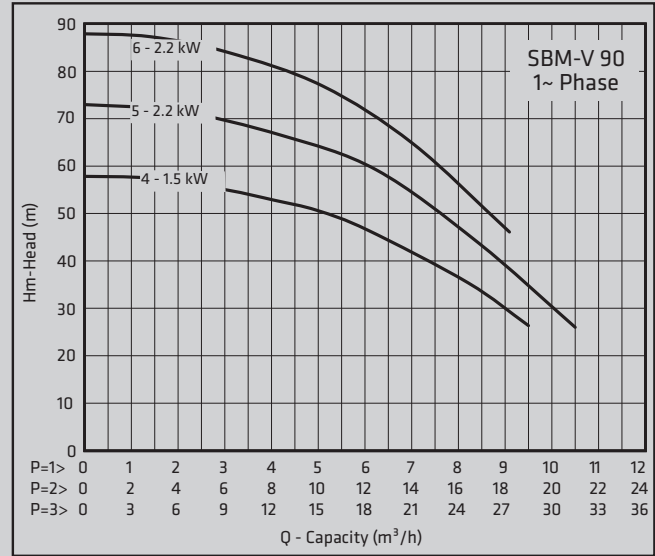
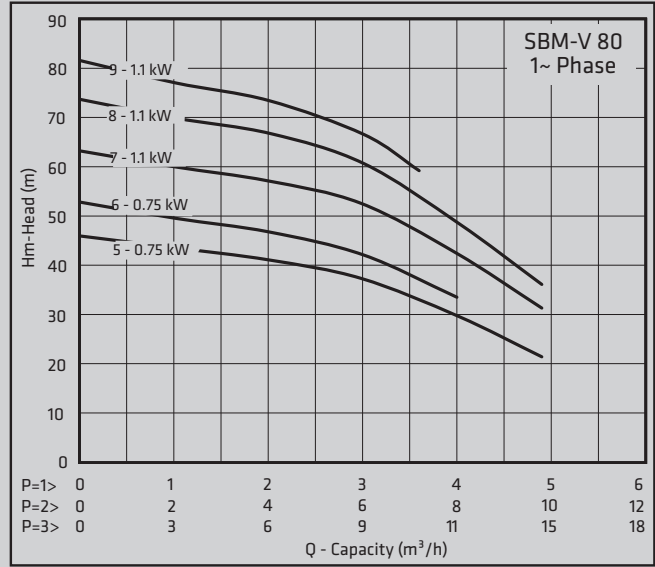

01.04.2023

Dikey Pompalı Tam Otomatik Paket Hidroforlar

Trifaze

Hidrofor Tipi	Motor		Liste Satış Fiyatı
	kW	rpm	
TH 1xSBT-V 80/5	0.75	2900	724 €
TH 2xSBT-V 80/5	0.75	2900	1.405 €
TH 3xSBT-V 80/5	0.75	2900	1.984 €
TH 1xSBT-V 80/6	0.75	2900	742 €
TH 2xSBT-V 80/6	0.75	2900	1.441 €
TH 3xSBT-V 80/6	0.75	2900	2.037 €
TH 1xSBT-V 80/7	1.1	2900	767 €
TH 2xSBT-V 80/7	1.1	2900	1.492 €
TH 3xSBT-V 80/7	1.1	2900	2.115 €
TH 1xSBT-V 80/8	1.1	2900	775 €
TH 2xSBT-V 80/8	1.1	2900	1.508 €
TH 3xSBT-V 80/8	1.1	2900	2.138 €
TH 1xSBT-V 80/9	1.1	2900	782 €
TH 2xSBT-V 80/9	1.1	2900	1.525 €
TH 3xSBT-V 80/9	1.1	2900	2.165 €
TH 1xSBT-V 80/10	1.5	2900	785 €
TH 2xSBT-V 80/10	1.5	2900	1.530 €
TH 3xSBT-V 80/10	1.5	2900	2.170 €
TH 1xSBT-V 80/11	1.5	2900	790 €
TH 2xSBT-V 80/11	1.5	2900	1.537 €
TH 3xSBT-V 80/11	1.5	2900	2.181 €
TH 1xSBT-V 80/12*	1.5	2900	794 €
TH 2xSBT-V 80/12*	1.5	2900	1.546 €
TH 3xSBT-V 80/12*	1.5	2900	2.196 €

Tank ve bağlantı hortumu hariç komple fiyattır.

* İşaretili hidroforlarda 16 bar'lık tank kullanılmalıdır.

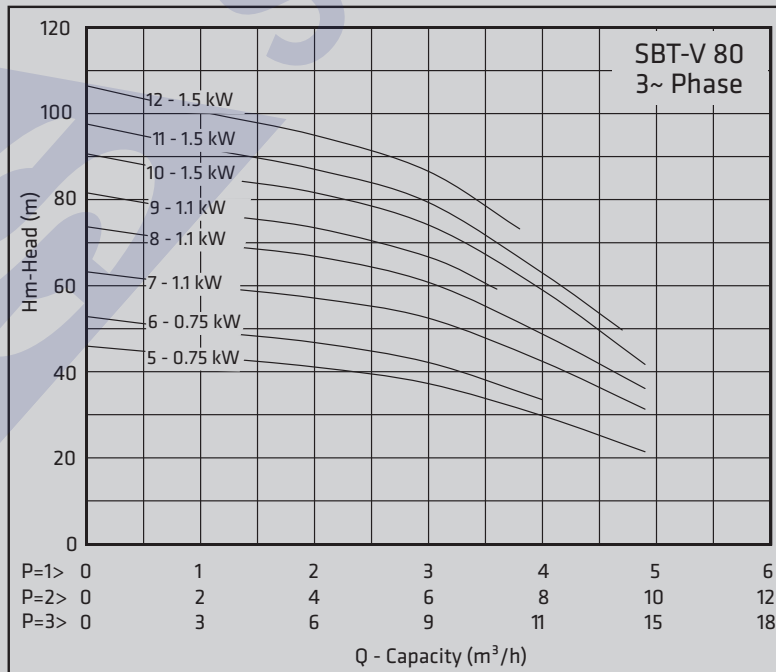

01.04.2023

Dikey Pompalı Tam Otomatik Paket Hidroforlar

Trifaze

Hidrofor Tipi	Motor		Liste Satış Fiyatı
	kW	rpm	
TH 1xSBT-V 90/4	1.5	2900	802 €
TH 2xSBT-V 90/4	1.5	2900	1.586 €
TH 3xSBT-V 90/4	1.5	2900	2.257 €
TH 1xSBT-V 90/5	2.2	2900	870 €
TH 2xSBT-V 90/5	2.2	2900	1.724 €
TH 3xSBT-V 90/5	2.2	2900	2.468 €
TH 1xSBT-V 90/6	2.2	2900	889 €
TH 2xSBT-V 90/6	2.2	2900	1.760 €
TH 3xSBT-V 90/6	2.2	2900	2.522 €
TH 1xSBT-V 90/7	3	2900	931 €
TH 2xSBT-V 90/7	3	2900	1.845 €
TH 3xSBT-V 90/7	3	2900	2.650 €
TH 1xSBT-V 90/8*	3	2900	944 €
TH 2xSBT-V 90/8*	3	2900	1.869 €
TH 3xSBT-V 90/8*	3	2900	2.686 €
TH 1xSBT-V 90/9*	3	2900	950 €
TH 2xSBT-V 90/9*	3	2900	1.884 €
TH 3xSBT-V 90/9*	3	2900	2.708 €

TH 1xSBT-V 100/3	3	2900	968 €
TH 2xSBT-V 100/3	3	2900	1.950 €
TH 3xSBT-V 100/3	3	2900	2.796 €
TH 1xSBT-V 100/4	4	2900	1.025 €
TH 2xSBT-V 100/4	4	2900	2.063 €
TH 3xSBT-V 100/4	4	2900	2.965 €
TH 1xSBT-V 100/5	5.5	2900	1.074 €
TH 2xSBT-V 100/5	5.5	2900	2.163 €
TH 3xSBT-V 100/5	5.5	2900	3.115 €
TH 1xSBT-V 100/6*	5.5	2900	1.094 €
TH 2xSBT-V 100/6*	5.5	2900	2.201 €
TH 3xSBT-V 100/6*	5.5	2900	3.173 €
TH 1xSBT-V 100/7*	5.5	2900	1.113 €
TH 2xSBT-V 100/7*	5.5	2900	2.239 €
TH 3xSBT-V 100/7*	5.5	2900	3.231 €

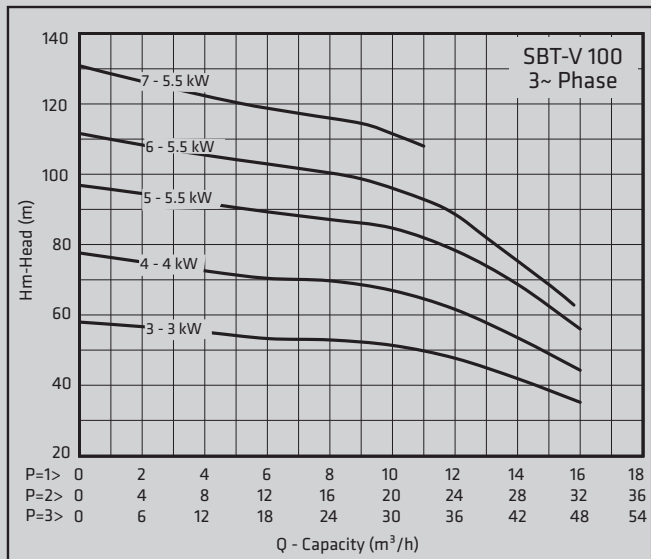
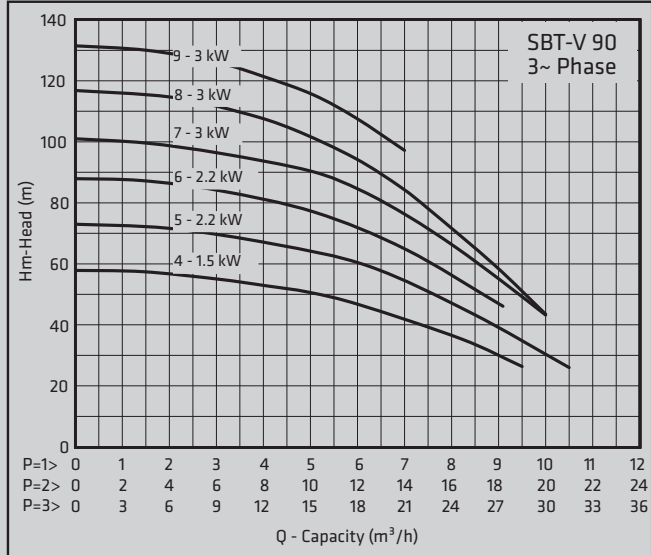

Tank ve bağlantı hortumu hariç komple fiyattır.

* İşaretli hidroforlarda 16 bar'lık tank kullanılmalıdır.

01.04.2023

Dikey Pompalı Tam Otomatik Paket Hidroforlar

Trifaze

Hidrofor Tipi	Motor		Liste Satış Fiyatı
	kW	rpm	
TH 1x SBT-V 130/2	4	2900	1.278 €
TH 2x SBT-V 130/2	4	2900	2.698 €
TH 3x SBT-V 130/2	4	2900	4.453 €
TH 1x SBT-V 130/3	5.5	2900	1.441 €
TH 2x SBT-V 130/3	5.5	2900	3.025 €
TH 3x SBT-V 130/3	5.5	2900	4.943 €
TH 1x SBT-V 130/4	7.5	2900	1.518 €
TH 2x SBT-V 130/4	7.5	2900	3.183 €
TH 3x SBT-V 130/4	7.5	2900	5.178 €
TH 1x SBT-V 130/5*	11	2900	2.052 €
TH 2x SBT-V 130/5*	11	2900	4.191 €
TH 3x SBT-V 130/5*	11	2900	6.705 €
TH 1x SBT-V 130/6*	11	2900	2.068 €
TH 2x SBT-V 130/6*	11	2900	4.223 €
TH 3x SBT-V 130/6*	11	2900	6.752 €
TH 1x SBT-V 130/7*	11	2900	2.084 €
TH 2x SBT-V 130/7*	11	2900	4.255 €
TH 3x SBT-V 130/7*	11	2900	6.800 €
TH 1x SBT-V 130/7*	15	2900	2.234 €
TH 2x SBT-V 130/7*	15	2900	4.555 €
TH 3x SBT-V 130/7*	15	2900	7.230 €

Tank ve bağlantı hortumu hariç komple fiyattır.

* İşaretili hidroforlarda 16 bar'lık tank kullanılmalıdır.

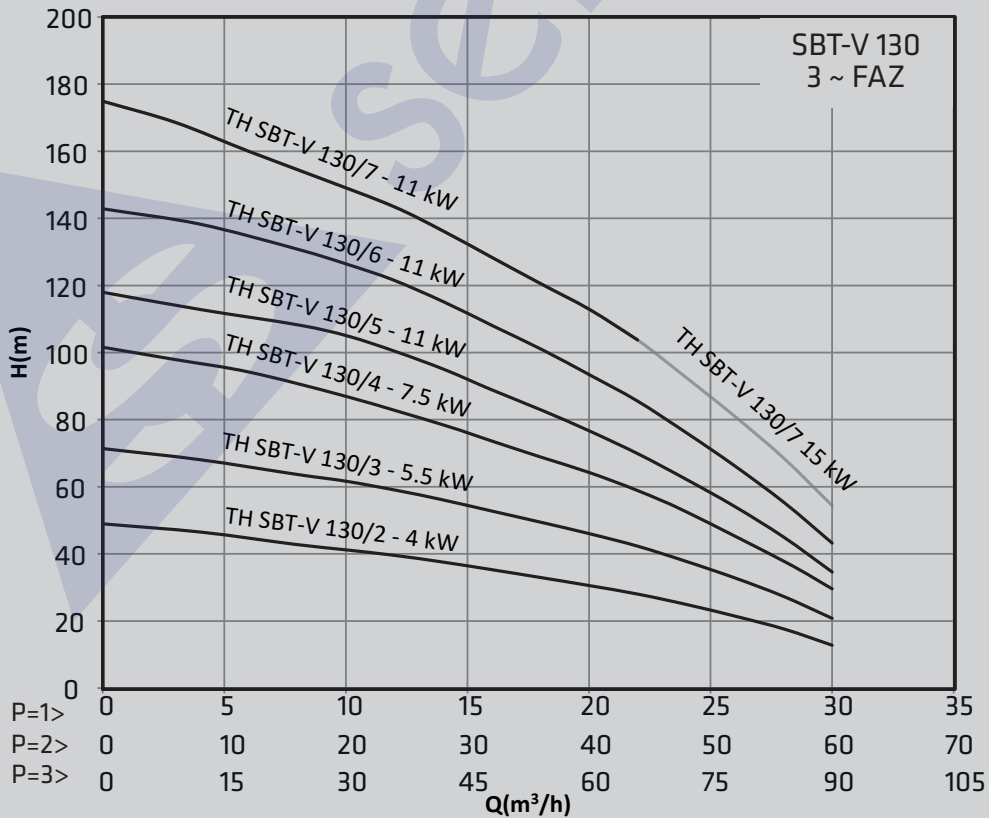

01.04.2023

Trifaze

Hidrofor Tipi	Motor		Liste Satış Fiyatı
	kW	rpm	
TH 1xSKM-V 32/2	3	2900	1.844 €
TH 2xSKM-V 32/2	3	2900	3.681 €
TH 3xSKM-V 32/2	3	2900	5.935 €
TH 1xSKM-V 32/3	4	2900	2.078 €
TH 2xSKM-V 32/3	4	2900	4.149 €
TH 3xSKM-V 32/3	4	2900	6.097 €
TH 1xSKM-V 32/4	5.5	2900	2.361 €
TH 2xSKM-V 32/4	5.5	2900	4.713 €
TH 3xSKM-V 32/4	5.5	2900	6.944 €
TH 1xSKM-V 32/5*	7.5	2900	2.570 €
TH 2xSKM-V 32/5*	7.5	2900	5.151 €
TH 3xSKM-V 32/5*	7.5	2900	7.600 €
TH 1xSKM-V 32/6*	11	2900	3.167 €
TH 2xSKM-V 32/6*	11	2900	6.282 €
TH 3xSKM-V 32/6*	11	2900	9.312 €

TH 1xSKM-V 40/2	7.5	2900	2.428 €
TH 2xSKM-V 40/2	7.5	2900	5.533 €
TH 3xSKM-V 40/2	7.5	2900	8.082 €
TH 1xSKM-V 40/3	11	2900	3.194 €
TH 2xSKM-V 40/3	11	2900	7.006 €
TH 3xSKM-V 40/3	11	2900	10.299 €
TH 1xSKM-V 40/4*	15	2900	3.571 €
TH 2xSKM-V 40/4*	15	2900	7.758 €
TH 3xSKM-V 40/4*	15	2900	11.412 €
TH 1xSKM-V 40/5*	18.5	2900	3.948 €
TH 2xSKM-V 40/5*	18.5	2900	8.508 €
TH 3xSKM-V 40/5*	18.5	2900	12.563 €

Tank ve bağlantı hortumu hariç komple fiyattır.

* İşaretli hidroforlarda 16 bar'lık tank kullanılmalıdır.

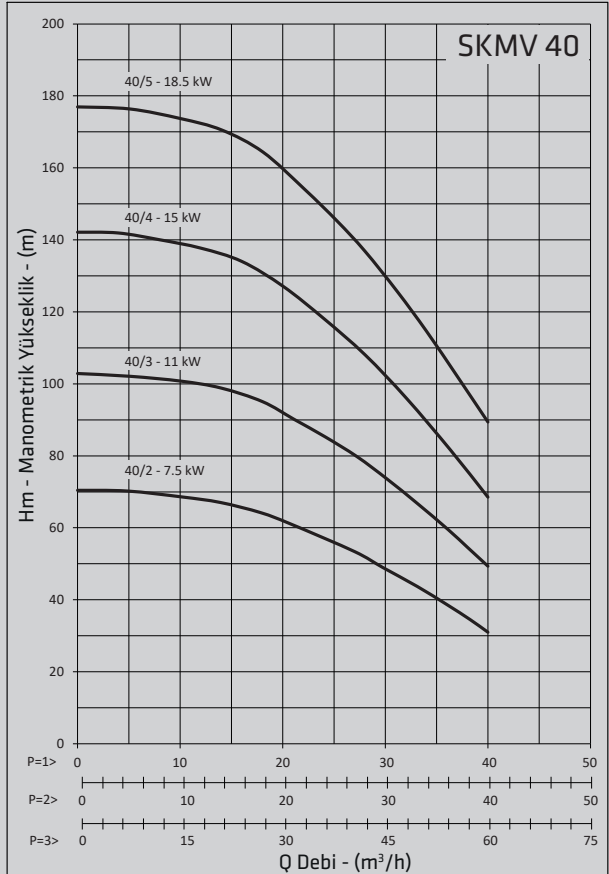
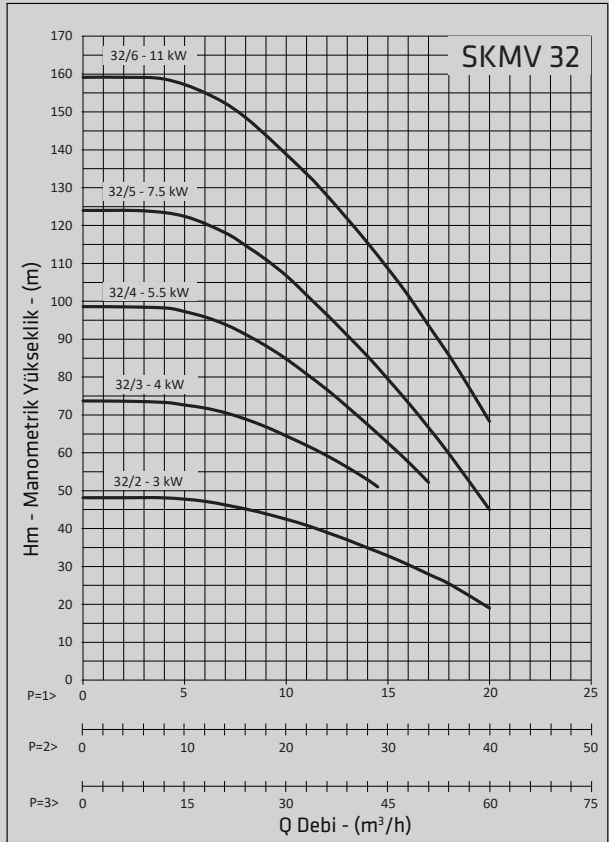

01.04.2023

Trifaze

Hidrofor Tipi	Motor		Liste Satış Fiyatı
	kW	rpm	
TH 1xSKM-V 50/2	11	2900	3.311 €
TH 2xSKM-V 50/2	11	2900	7.428 €
TH 3xSKM-V 50/2	11	2900	10.976 €
TH 1xSKM-V 50/2	15	2900	3.461 €
TH 2xSKM-V 50/2	15	2900	7.729 €
TH 3xSKM-V 50/2	15	2900	11.406 €

TH 1xSKM-V 50/3*	18.5	2900	3.861 €
TH 2xSKM-V 50/3*	18.5	2900	8.528 €
TH 3xSKM-V 50/3*	18.5	2900	12.632 €
TH 1xSKM-V 50/3*	22	2900	4.417 €
TH 2xSKM-V 50/3*	22	2900	9.590 €
TH 3xSKM-V 50/3*	22	2900	14.198 €

TH 1xSKM-V 50/4*	22	2900	4.658 €
TH 2xSKM-V 50/4*	22	2900	10.073 €
TH 3xSKM-V 50/4*	22	2900	14.922 €
TH 1xSKM-V 50/4*	30	2900	5.526 €
TH 2xSKM-V 50/4*	30	2900	11.745 €
TH 3xSKM-V 50/4*	30	2900	17.684 €

TH 1xSKM-V 65/2	22	2900	4.880 €
TH 2xSKM-V 65/2	22	2900	10.931 €
TH 3xSKM-V 65/2	22	2900	16.205 €
TH 1xSKM-V 65/2*	30	2900	5.759 €
TH 2xSKM-V 65/2*	30	2900	12.626 €
TH 3xSKM-V 65/2*	30	2900	19.001 €

TH 1xSKM-V 65/3*	37	2900	6.553 €
TH 2xSKM-V 65/3*	37	2900	14.269 €
TH 3xSKM-V 65/3*	37	2900	21.726 €
TH 1xSKM-V 65/3*	45	2900	7.252 €
TH 2xSKM-V 65/3*	45	2900	15.605 €
TH 3xSKM-V 65/3*	45	2900	23.725 €

Tank ve bağlantı hortumu hariç komple fiyattır.
* İşaretli hidroforlarda 16 bar'lık tank kullanılmalıdır.

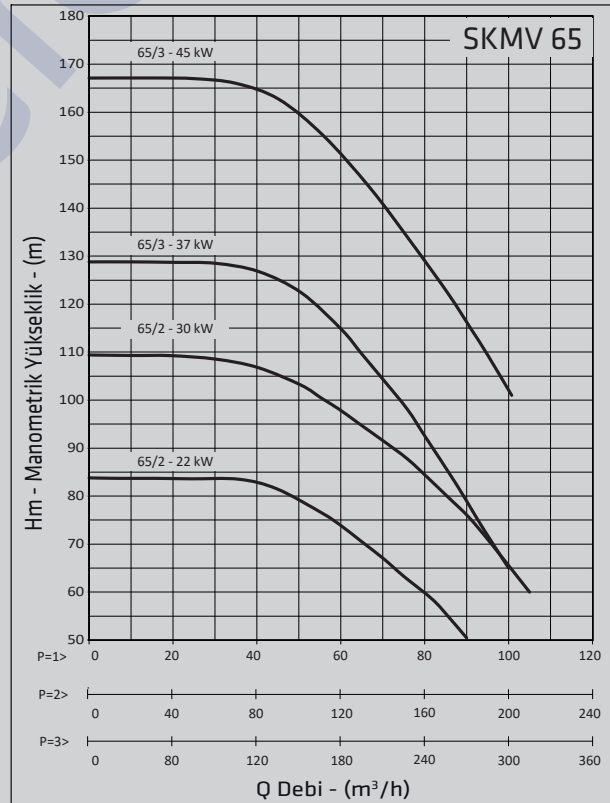
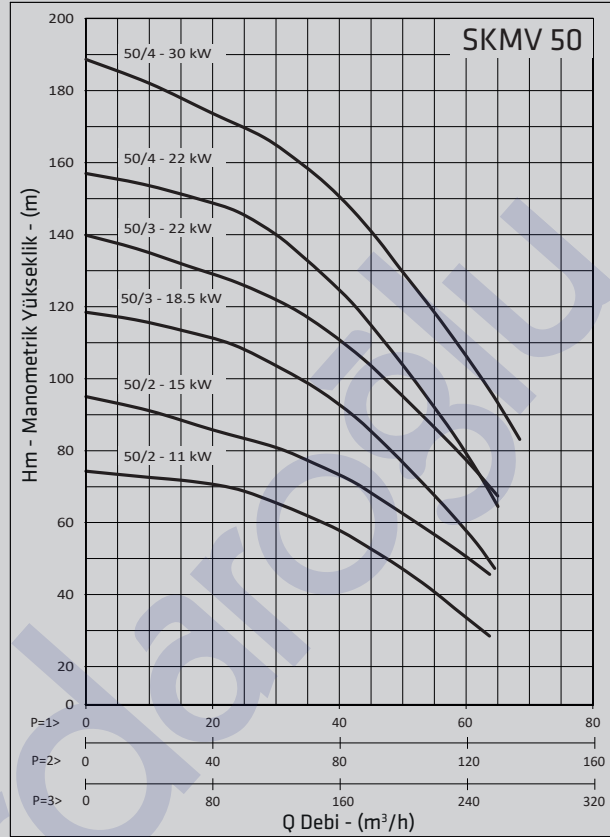

01.04.2023

Frekans Kontrollü Hidrofor Pano İlave Fiyatları

Hidrofor Pano Tipleri (PFC)	Liste Satış Fiyatı
1 x 0,75 kW	1.355 €
1 x 1,1 kW	1.389 €
1 x 1,5 kW	1.408 €
1 x 2,2 kW	1.489 €
1 x 3 kW	1.559 €
1 x 4 kW	1.611 €
1 x 5,5 kW	1.780 €
1 x 7,5 kW	1.965 €
1 x 11 kW	2.191 €
1 x 15 kW	2.587 €
1 x 18,5 kW	2.932 €
1 x 22 kW	3.426 €
1 x 30 kW	5.045 €
1 x 37 kW	5.839 €
1 x 45 kW	6.946 €

Hidrofor Pano Tipleri (PFC)	Liste Satış Fiyatı
2 x 0,75 kW	1.614 €
2 x 1,1 kW	1.648 €
2 x 1,5 kW	1.701 €
2 x 2,2 kW	1.748 €
2 x 3 kW	1.820 €
2 x 4 kW	1.874 €
2 x 5,5 kW	2.046 €
2 x 7,5 kW	2.232 €
2 x 11 kW	2.574 €
2 x 15 kW	3.103 €
2 x 18,5 kW	3.594 €
2 x 22 kW	4.111 €
2 x 30 kW	5.698 €
2 x 37 kW	6.523 €
2 x 45 kW	8.499 €

Hidrofor Pano Tipleri (PFC)	Liste Satış Fiyatı
3 x 0,75 kW	1.678 €
3 x 1,1 kW	1.712 €
3 x 1,5 kW	1.764 €
3 x 2,2 kW	1.812 €
3 x 3 kW	1.887 €
3 x 4 kW	1.946 €
3 x 5,5 kW	2.122 €
3 x 7,5 kW	2.314 €
3 x 11 kW	2.719 €
3 x 15 kW	3.265 €
3 x 18,5 kW	3.854 €
3 x 22 kW	5.239 €
3 x 30 kW	6.066 €
3 x 37 kW	6.526 €
3 x 45 kW	8.913 €

Hidrofor Pano Tipleri (ECO)	Liste Satış Fiyatı
2 x 0,75 kW	1.288 €
2 x 1,1 kW	1.323 €
2 x 1,5 kW	1.375 €
2 x 2,2 kW	1.423 €
2 x 3 kW	1.491 €
2 x 4 kW	1.544 €
2 x 5,5 kW	1.713 €
2 x 7,5 kW	1.894 €
2 x 11 kW	2.029 €
2 x 15 kW	2.644 €
2 x 18,5 kW	3.012 €
2 x 22 kW	3.463 €
2 x 30 kW	4.731 €
2 x 37 kW	5.467 €
2 x 45 kW	7.037 €

Hidrofor Pano Tipleri (ECO)	Liste Satış Fiyatı
3 x 0,75 kW	1.368 €
3 x 1,1 kW	1.403 €
3 x 1,5 kW	1.456 €
3 x 2,2 kW	1.502 €
3 x 3 kW	1.574 €
3 x 4 kW	1.628 €
3 x 5,5 kW	1.804 €
3 x 7,5 kW	1.984 €
3 x 11 kW	2.090 €
3 x 15 kW	2.650 €
3 x 18,5 kW	3.059 €
3 x 22 kW	3.668 €
3 x 30 kW	5.062 €
3 x 37 kW	5.268 €
3 x 45 kW	7.101 €

Frekans Kontrollü Panoların Karşılaştırma Tablosu

	PFC	ECO
Gelişmiş Türkçe operatör paneli	√	√
Hidrofor ve sirkülasyon pompalarına uyum	√	√
Gerçek zamanlı eş yaşlandırma	√	-(*)
Manuel çalışma seçeneği	√	-(**)
Dâhili MODBUS (RS 485)	√	√
CE Normu	√	√
Faz sırası ve faz hatası koruması	√	√
Susuz çalışmaya karşı koruma	√	√
Uyku - uyanma fonksiyonu	√	√
Hata kaydı ve hata uyarısı	√	√
Termostat kontrollü pano havalandırması	√	√
Kısa devre ve aşırı yük koruması	√	√
Otomasyon için gerilimsiz kontaklar	√	√
Uzaktan start-stop	√	√

Not:

(*) Sürücünden çalışan pompa sabit, yardımcı pompalar eş yaşlandırmalı çalışır.

(**) Sürücü arızalandığında sürücünden çalışan pompa durur. Diğer pompalar manuel konumda çalışmaya devam eder.

Tekli hidrofor ve pompalarda ECO tipi pano yapılamamaktadır.

01.04.2023

Frekans Kontrollü Pompa Pano Fiyatları

Pompa Pano Tipleri (PFC)	Liste Satış Fiyatı
1 x 0,75 kW	1.315 €
1 x 1,1 kW	1.348 €
1 x 1,5 kW	1.368 €
1 x 2,2 kW	1.448 €
1 x 3 kW	1.518 €
1 x 4 kW	1.570 €
1 x 5,5 kW	1.740 €
1 x 7,5 kW	1.925 €
1 x 11 kW	2.313 €
1 x 15 kW	2.743 €
1 x 18,5 kW	3.088 €
1 x 22 kW	3.740 €
1 x 30 kW	5.530 €
1 x 37 kW	6.410 €
1 x 45 kW	7.573 €

Pompa Pano Tipleri (PFC)	Liste Satış Fiyatı
2 x 0,75 kW	1.713 €
2 x 1,1 kW	1.748 €
2 x 1,5 kW	1.800 €
2 x 2,2 kW	1.848 €
2 x 3 kW	1.920 €
2 x 4 kW	1.973 €
2 x 5,5 kW	2.145 €
2 x 7,5 kW	2.338 €
2 x 11 kW	2.940 €
2 x 15 kW	3.538 €
2 x 18,5 kW	4.030 €
2 x 22 kW	4.813 €
2 x 30 kW	6.678 €
2 x 37 kW	7.730 €
2 x 45 kW	9.745 €

Pompa Pano Tipleri (PFC)	Liste Satış Fiyatı
3 x 0,75 kW	1.868 €
3 x 1,1 kW	1.900 €
3 x 1,5 kW	1.953 €
3 x 2,2 kW	2.000 €
3 x 3 kW	2.075 €
3 x 4 kW	2.135 €
3 x 5,5 kW	2.310 €
3 x 7,5 kW	2.510 €
3 x 11 kW	3.320 €
3 x 15 kW	3.948 €
3 x 18,5 kW	4.563 €
3 x 22 kW	6.323 €
3 x 30 kW	7.820 €
3 x 37 kW	8.880 €
3 x 45 kW	11.323 €

Pompa Pano Tipleri (ECO)	Liste Satış Fiyatı
2 x 0,75 kW	1.388 €
2 x 1,1 kW	1.423 €
2 x 1,5 kW	1.475 €
2 x 2,2 kW	1.523 €
2 x 3 kW	1.590 €
2 x 4 kW	1.643 €
2 x 5,5 kW	1.813 €
2 x 7,5 kW	2.000 €
2 x 11 kW	2.395 €
2 x 15 kW	3.080 €
2 x 18,5 kW	3.448 €
2 x 22 kW	4.165 €
2 x 30 kW	5.710 €
2 x 37 kW	6.673 €
2 x 45 kW	8.283 €

Pompa Pano Tipleri (ECO)	Liste Satış Fiyatı
3 x 0,75 kW	1.558 €
3 x 1,1 kW	1.593 €
3 x 1,5 kW	1.645 €
3 x 2,2 kW	1.690 €
3 x 3 kW	1.763 €
3 x 4 kW	1.818 €
3 x 5,5 kW	1.993 €
3 x 7,5 kW	2.180 €
3 x 11 kW	2.693 €
3 x 15 kW	3.333 €
3 x 18,5 kW	3.768 €
3 x 22 kW	4.753 €
3 x 30 kW	6.815 €
3 x 37 kW	7.620 €
3 x 45 kW	9.510 €

Frekans Kontrollü Panoların Karşılaştırma Tablosu

	PFC	ECO
Gelişmiş Türkçe operatör paneli	√	√
Hidrofor ve sirkülasyon pompalarına uyum	√	√
Gerçek zamanlı eş yaşlandırma	√	-(*)
Manuel çalışma seçeneği	√	-(**)
Dâhili MODBUS (RS 485)	√	√
CE Normu	√	√
Faz sırası ve faz hatası koruması	√	√
Susuz çalışmaya karşı koruma	√	√
Uyku - uyanma fonksiyonu	√	√
Hata kaydı ve hata uyarısı	√	√
Termostat kontrollü pano havalandırması	√	√
Kısa devre ve aşırı yük koruması	√	√
Otomasyon için gerilimsiz kontaklar	√	√
Uzaktan start-stop	√	√

Not:

(*) Sürücünden çalışan pompa sabit, yardımcı pompalar eş yaşlandırmalı çalışır.

(**) Sürücü arızalandığında sürücünden çalışan pompa durur. Diğer pompalar manuel konumda çalışmaya devam eder.

Tekli hidrofor ve pompalarda ECO tipi pano yapılamamaktadır.

01.04.2023

Standart

Pompa • Yangın Söndürme Sistemleri • Hidrofor

NMT
ISLAK ROTORLU
SİRKÜLASYON POMPALARI



01.04.2023

NMT PLUS

Pompa Tipleri	EEl	A (mm)	B	Pmax (w)	Fiyat
NMT PLUS 15/40-130	0,16	130	Rp ¾"	20	152 €
NMT PLUS 25/40-130	0,16	130	Rp 1"	20	152 €
NMT PLUS 25/60-130	0,18	130	Rp 1"	35	160 €
NMT PLUS 25/80-130	0,21	130	Rp 1"	55	173 €
NMT PLUS 25/90-130	0,23	130	Rp 1"	100	223 €
NMT PLUS 32/40-180	0,15	180	Rp 1¼"	20	161 €
NMT PLUS 32/60-180	0,17	180	Rp 1¼"	35	163 €
NMT PLUS 32/80-180	0,19	180	Rp 1¼"	55	173 €

Pompa Tipleri	EEl	A (mm)	B	Pmax (w)	Fiyat
NMTD PLUS 25/60-180	0,17	180	Rp 1"	2x35	320 €
NMTD PLUS 25/80-180	0,19	180	Rp 1"	2x55	358 €
NMTD PLUS 25/90-180	0,21	180	Rp 1"	2x100	419 €

Rakor Tipleri	Fiyat
Rp ¾"	10 €
Rp 1"	11 €
Rp 1¼"	14 €

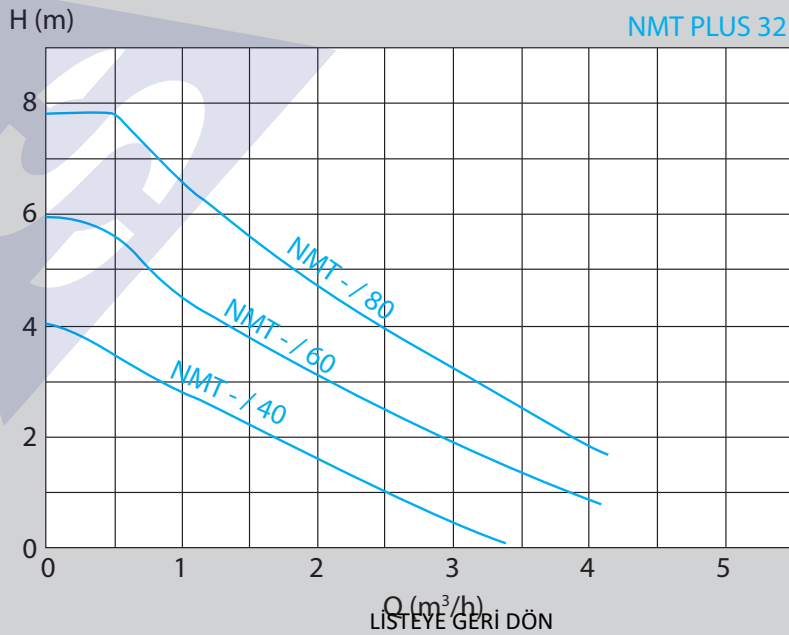
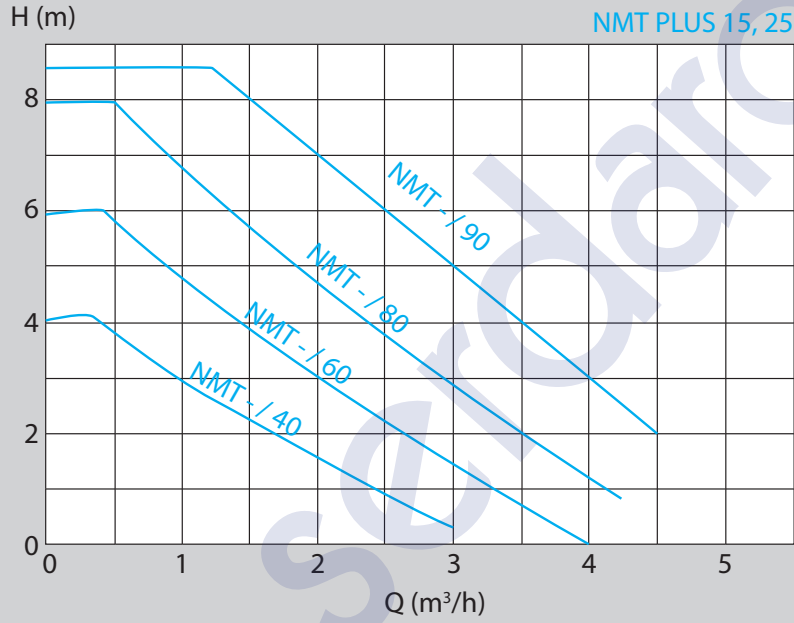

LİSTEYE GERİ DÖN

01.04.2023

Pompa Tipleri	EEl	A (mm)	B	Pmax (w)	Fiyat
NMT SMART 25/40-180	≤ 0,19	180	Rp 1	70	560 €
NMT SMART 25/60-180	≤ 0,21	180	Rp 1	90	568 €
NMT SMART 25/100-180	≤ 0,21	180	Rp 1	180	829 €
NMT SMART 32/60-180	≤ 0,21	180	Rp 1¼	90	568 €
NMT SMART 32/100-180	≤ 0,21	180	Rp 1¼	180	839 €
NMT SMART 32/120-180	≤ 0,21	180	Rp 1¼	180	858 €

Rakor Tipleri	Fiyat
Rp ¾"	10 €
Rp 1"	11 €
Rp 1¼"	14 €

Pompa Tipleri	EEl	A (mm)	B	Pmax (w)	Fiyat
NMTD SMART 32/60-180	≤ 0,21	180	Rp 1¼	2x90	1.172 €
NMTD SMART 32/100-180	≤ 0,21	180	Rp 1¼	2x180	1.665 €

Pompa Tipleri	EEl	A (mm)	B	Pmax (w)	Fiyat
NMT SMART 32/40 F	≤ 0,21	220	DN 32	60	670 €
NMT SMART 32/60 F	≤ 0,21	220	DN 32	90	697 €
NMT SMART 32/100 F	≤ 0,21	220	DN 32	180	755 €
NMT SMART 40/60 F	≤ 0,21	220	DN 40	90	730 €
NMT SMART 40/100 F	≤ 0,21	220	DN 40	180	760 €
NMT SMART 50/100 F	≤ 0,21	240	DN 50	180	963 €

Pompa Tipleri	EEl	A (mm)	B	Pmax (w)	Fiyat
NMTD SMART 40/60 F	≤ 0,21	220	DN 40	2x90	1.425 €
NMTD SMART 40/100 F	≤ 0,21	220	DN 40	2x180	1.529 €

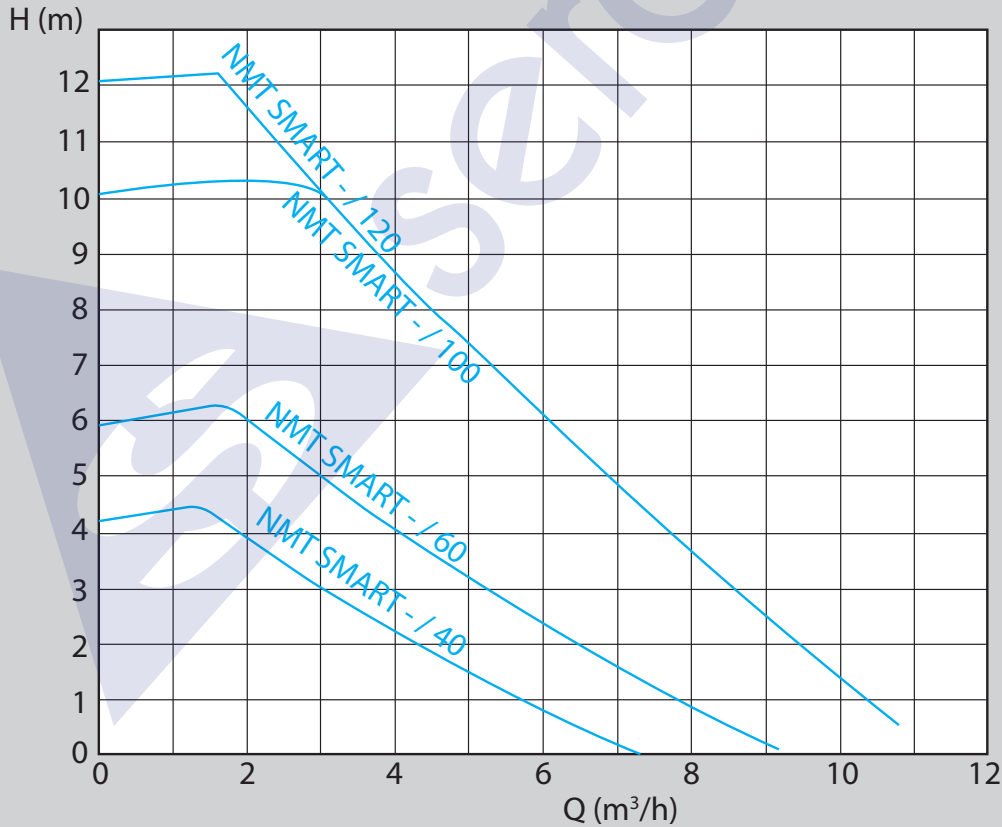

01.04.2023

Pompa Tipleri	EEl	A (mm)	B	PN	Pmax (w)	Fiyat
NMT MAX 32/120 F	≤ 0,20	220	DN 32	6/10	370	1.136 €
NMT MAX 40/80 F	≤ 0,21	250	DN 40	6/10	270	1.040 €
NMT MAX 40/120 F	≤ 0,21	250	DN 40	6/10	480	1.450 €
NMT MAX 40/180 F	≤ 0,21	250	DN 40	6/10	680	2.095 €
NMT MAX 50/120 F	≤ 0,21	280	DN 50	6/10	560	1.905 €
NMT MAX 65/120 F	≤ 0,20	340	DN 65	6/10	810	2.420 €
NMT MAX C 65/180 F	≤ 0,20	340	DN 65	6/10	1550	3.080 €
NMT MAX C 80/120 F	≤ 0,20	360	DN 80	10	1380	3.280 €

Pompa Tipleri	EEl	A (mm)	B	PN	Pmax (w)	Fiyat
NMTD MAX 40/120 F	≤ 0,21	250	DN 40	6/10	2x480	2.925 €
NMTD MAX 50/120 F	≤ 0,21	280	DN 50	6/10	2x560	3.420 €
NMTD MAX 65/120 F	≤ 0,20	340	DN 65	6/10	2x810	4.630 €
NMTD MAX C 80/120 F	≤ 0,20	360	DN 80	10	2x1380	5.720 €

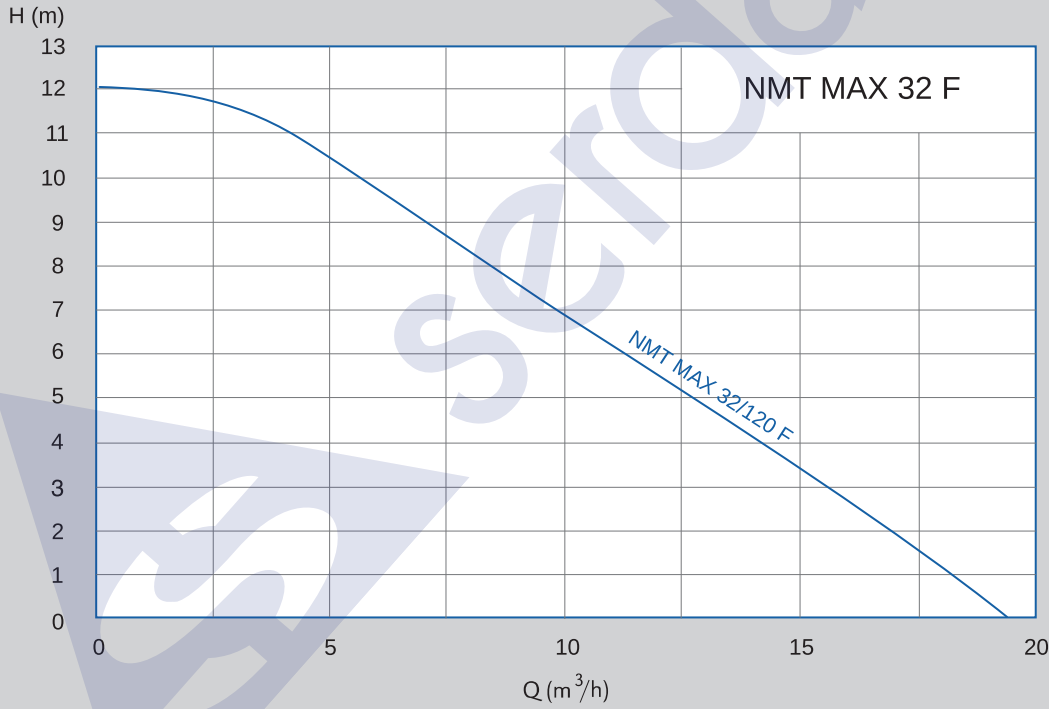

01.04.2023

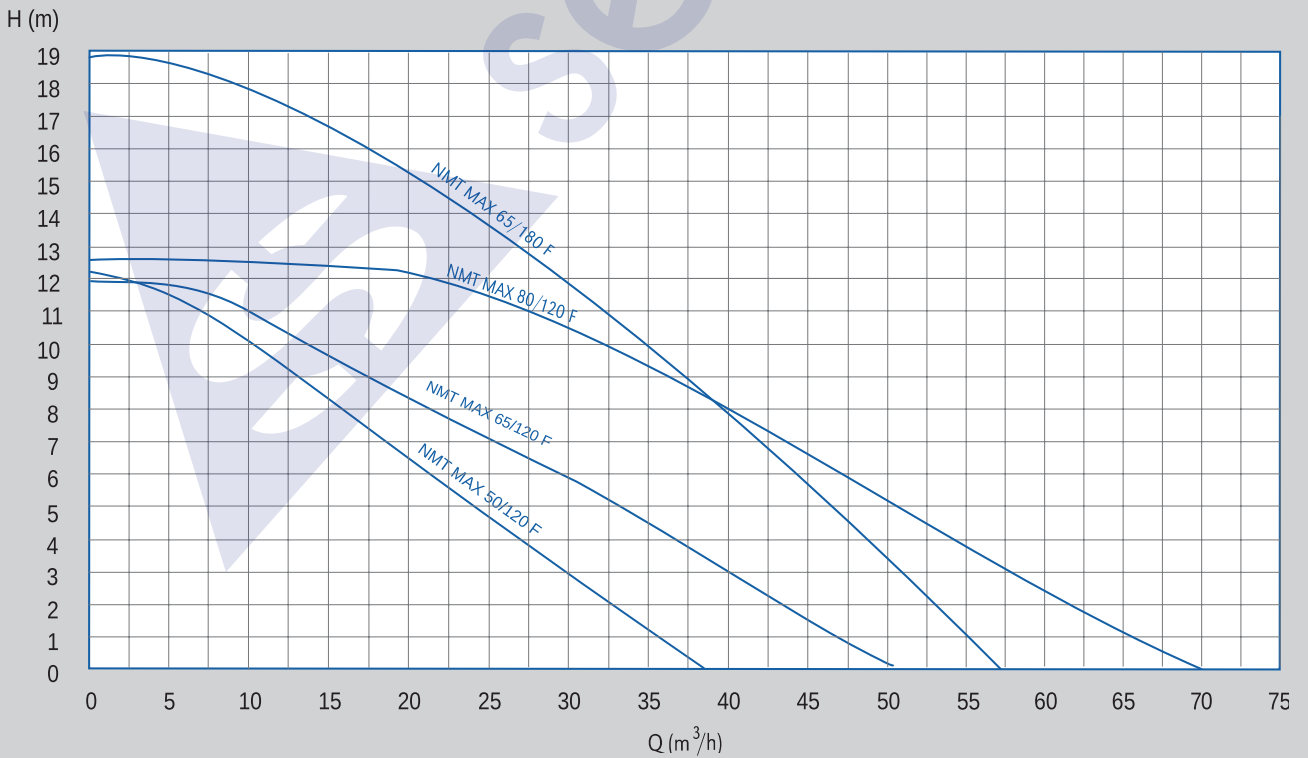
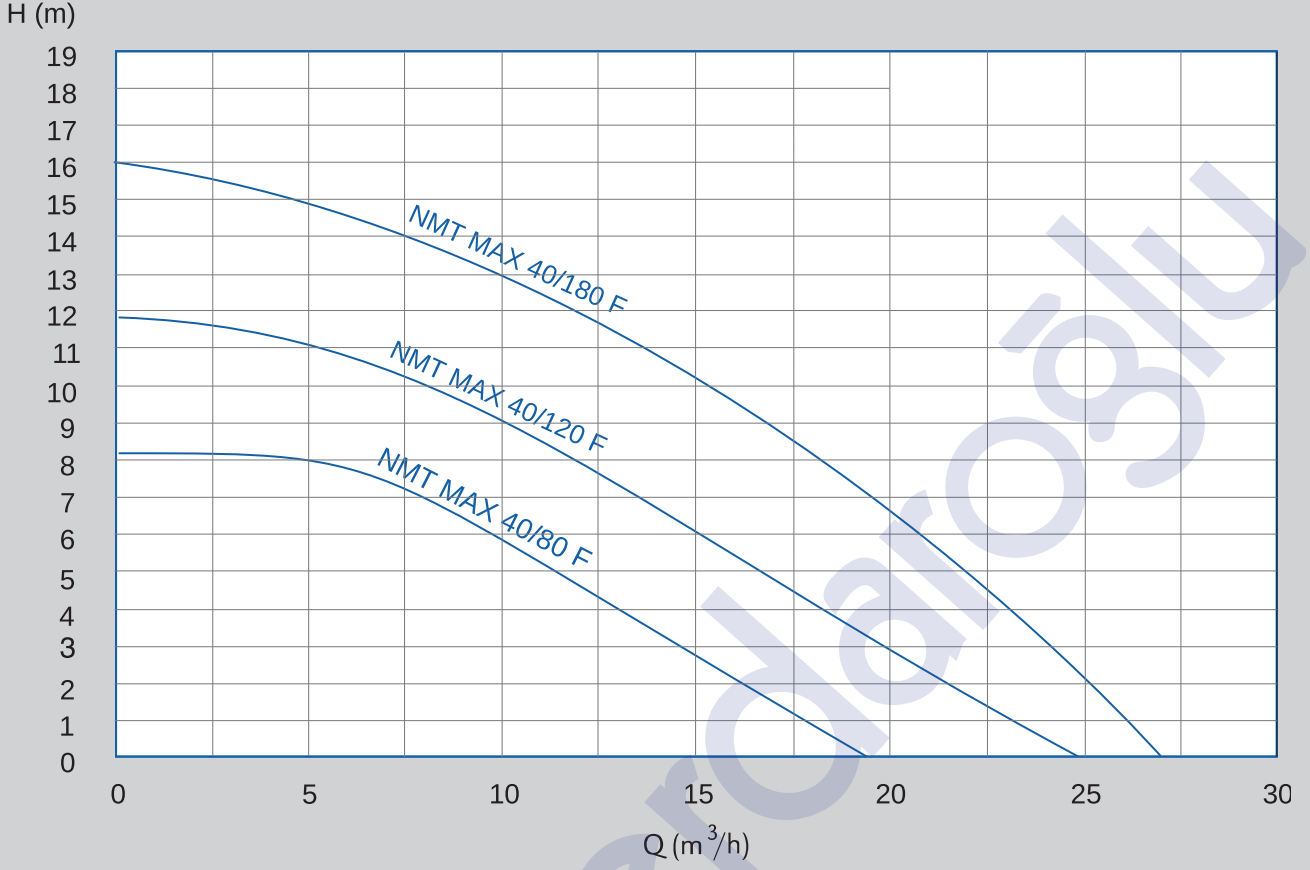

01.04.2023

NMT LAN

NMT

Pompa Tipleri	EEl	A (mm)	B	PN	Pmax (w)	Fiyat
NMTD LAN 65 F	≤ 0,23	340	DN 65	6/10	2x1100	3.480 €
NMTD LAN 80 F	≤ 0,23	360	DN 80	10	2x1600	4.325 €

Stoklarla sınırlıdır. Bilgi almak için firmamıza başvurunuz.

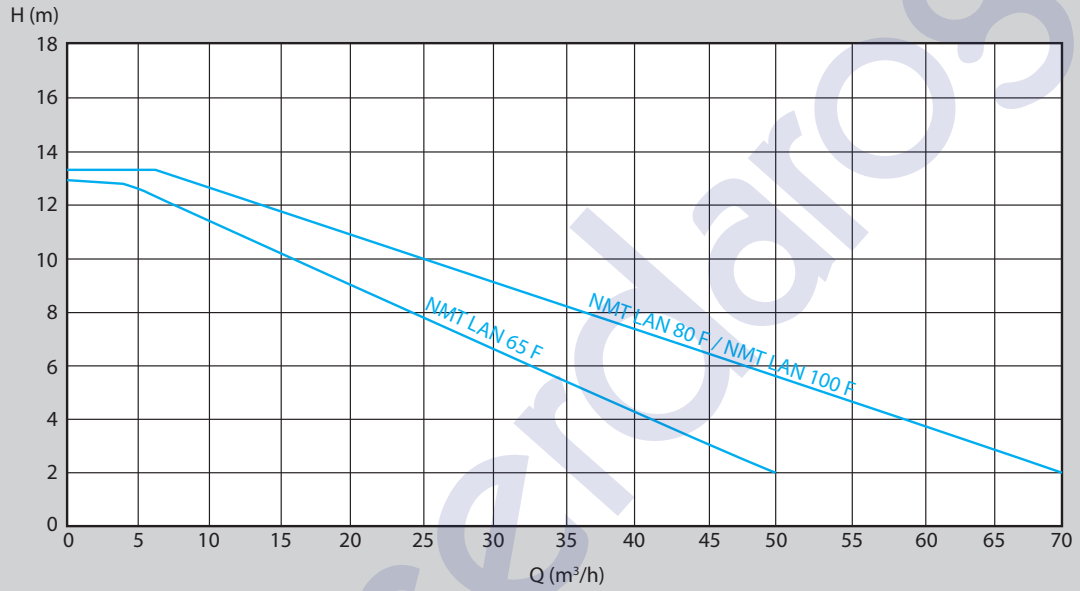

01.04.2023

KAT SAYISINA GÖRE PRATİK BAR SEÇİM TABLOSU

Tablo 1

KAT SAYISI	PA(Bar)	KAT SAYISI	PA(Bar)
1	2.4	16	7.6
2	2.8	17	7.9
3	3.1	18	8.3
4	3.5	19	8.6
5	3.8	20	9
6	4.1	21	9.3
7	4.5	22	9.7
8	4.8	23	10
9	5.2	24	10.4
10	5.5	25	10.7
11	5.9	26	11
12	6.2	27	11.4
13	6.6	28	11.7
14	6.9	29	12.1
15	7.3	30	12.4

DAİRE SAYISINA GÖRE PRATİK (m³/h) SEÇİM TABLOSU

Tablo 2

DAİRE SAYISI	m ³ /h	DAİRE SAYISI	Q (m ³ /h)	DAİRE SAYISI	Q (m ³ /h)	DAİRE SAYISI	Q (m ³ /h)	DAİRE SAYISI	Q (m ³ /h)
2	0.8	32	6.7	64	13.4	128	26.8	256	53.6
4	1.6	34	7.2	68	14.4	136	28.8	272	57.6
6	1.8	36	7.6	72	15.2	144	30.4	288	60.8
8	2	38	8	76	16	152	32	304	64
10	2.4	40	8.4	80	16.8	160	33.6	320	67.2
12	2.5	42	8.8	84	17.6	168	35.2	336	70.4
14	2.9	44	9.3	88	18.6	176	37.2	352	74.4
16	3.4	46	9.7	92	19.4	184	38.8	368	77.6
18	3.8	48	10.1	96	20.2	192	40.4	384	80.8
20	4.2	50	10.5	100	21	200	42	400	84
22	4.6	52	10.9	104	21.8	208	43.6	416	87.2
24	5	54	11.3	108	22.6	216	45.2	432	90.4
26	5.5	56	11.8	112	23.6	224	47.2	448	94.4
28	5.9	58	12.2	116	24.4	232	48.8	464	97.6
30	6.3	60	12.6	120	25.2	240	50.4	480	100.8

Serdaroğlu



**1986'dan Beri Tek Odağımız
Müşterilerimiz...**



KLİMA SİSTEMLERİ

FIYAT LİSTESİ

 ^{1986'dan beri} **serdaroğlu**[®]
TESİSAT TEKNİK MALZEME SAN. TİC. A.Ş.

01.08.2025

KLİMALAR

DUVAR TİPİ SPLIT KLİMA	GÖRSEL	KAPASİTE (BTU/h)		PEŞİN FİYAT (TL)
		Soğutma	Isıtma	
R32 PULAR	A++/A+	EUROVENT CERTIFIED PERFORMANCE		
GWH09AGAXB		8.530 (1.706 - 11.089)	9.553 (1.706 - 12.283)	41.506,41
GWH12AGBXB		11.000 (3.070 - 12.283)	11.600 (3.070 - 13.648)	45.673,08
GWH18AGD		15.700 (3.412 - 18.083)	17.742 (2.388 - 19.277)	66.105,77
GWH24AGD		21.000 (6.100 - 23.500)	22.000 (4.400 - 27.000)	82.131,41
R32 FAIRY BEYAZ	A++/A+	EUROVENT CERTIFIED PERFORMANCE		
GWH09ACC (BEYAZ)		9.212 (2.730 - 12.966)	10.236 (3.071 - 14.501)	46.153,85
GWH12ACC (BEYAZ)		11.976 (3.071 - 15.013)	13.000 (3.071 - 16.036)	51.682,69
GWH18ACD (BEYAZ)		17.742 (3.412 - 20.813)	19.107 (3.753 - 22.519)	76.121,79
GWH24ACE (BEYAZ)		24.200 (6.800 - 30.200)	26.600 (6.150 - 32.200)	93.108,97
R32 FAIRY GÜMÜŞ/SİYAH	A++/A+	EUROVENT CERTIFIED PERFORMANCE		
GWH09ACC (GÜMÜŞ/SİYAH)		9.212 (2.730 - 12.966)	10.236 (3.071 - 14.501)	51.282,05
GWH12ACC (GÜMÜŞ/SİYAH)		11.976 (3.071 - 15.013)	13.000 (3.071 - 16.036)	57.692,31
GWH18ACD (GÜMÜŞ/SİYAH)		17.742 (3.412 - 20.813)	19.107 (3.753 - 22.519)	81.891,03
GWH24ACE (GÜMÜŞ/SİYAH)		24.200 (6.800 - 30.200)	26.600 (6.150 - 32.200)	102.243,59

R32 T-FRESH	3 YIL GARANTİ	A++/A+	GÖRSEL	KAPASİTE (BTU/h)		PEŞİN FİYAT (TL)
				Soğutma	Isıtma	
EUROVENT CERTIFIED PERFORMANCE						
GVH24AMXF-K6DNC7A		24.566 (3.310-28.661)	26.955 (2.184-30.026)	91.185,90		
GVH48ALXH-K6DNC7A		41.968 (5.118-46.062)	46.062 (9.554-47.768)	135.016,03		

MULTİ TİP KLİMA	GÖRSEL	KAPASİTE (BTU/h)		PEŞİN FİYAT (TL)
		Soğutma	Isıtma	
R32 MULTİ DİŞ ÜNİTE		EUROVENT CERTIFIED PERFORMANCE		
GWHD18NK600 (2 İç Ünite)		18.100 (7.300 - 19.800)	19.300 (8.800 - 22.200)	42.548,08
GWHD21NK600 (3 İç Ünite)		20.800 (7.500 - 28.300)	22.200 (9.200 - 29.000)	49.182,69
GWHD24NK600 (3 İç Ünite)		24.200 (7.850 - 31.400)	29.300 (9.600 - 31.400)	56.538,46
GWHD28NK600 (4 İç Ünite)		28.000 (7.800 - 37.500)	32.400 (9.600 - 35.000)	60.432,69
GWHD36NK600 (4 İç Ünite)		36.200 (8.900 - 40.900)	40.900 (10.200 - 47.800)	86.394,23
GWHD42NK600 (5 İç Ünite)	41.300 (8.900 - 51.900)	44.400 (10.200 - 52.900)	98.870,19	

R32 PULAR DUVAR TİPİ İÇ ÜNİTE	GÖRSEL	KAPASİTE (BTU/h)		PEŞİN FİYAT (TL)
		Soğutma	Isıtma	
EUROVENT CERTIFIED PERFORMANCE				
GWH07AGA-K6DNA1A/I		7.506	8.189	9.951,92
GWH09AGAXB-K6DNA1B/I		8.530	9.553	11.466,35
GWH12AGBXB-K6DNA1A/I		11.000	11.600	12.331,73
GWH18AGD-K6DNA1D/I		15.700	17.742	17.524,04
GWH24AGD-K6DNA1C/I		21.000	22.000	19.557,69

Şehrin Görünmez Kahramanı

Serdaroğlu



İnovatif Çözüm Ortağı



Müşteri Odaklı
Hizmet Anlayışı



TESİSAT
SİSTEMLERİ

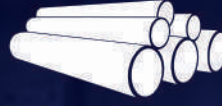

BORU



Sektörün Lider İsimlerinin
Proje Ortağı



YANGIN
SÖNDÜRME
SİSTEMLERİ



POMPA VE HİDROFOR
SİSTEMLERİ



Teknik Destek Hizmeti



İKLİMLENDİRME
HAVALANDIRMA
SİSTEMLERİ



ISITMA
SİSTEMLERİ



Yükselen Ticari
Başarı



Türkiye'nin Her Yerine
Güvenli Teslimat